

### LITE KITS

- Low Profile
- Self Attaching
- False Mullion
- Thru Bolted
- Round
- Stainless Steel
- Security

### LOUVERS

- Steel
- No Vision
- Aluminum
- Dark Room
- Fusible Link

### GLASS

- Fire Rated
- Impact Safety Rated
- Wired
- Safety Wired
- Glass Ceramic
- Tempered
- Insulated
- Polycarbonate

### METAL EDGES/ ASTRAGALS

- Door Aligning Astragals
- "Z" Astragals
- Door Edges
- Double Egress
- Astragals

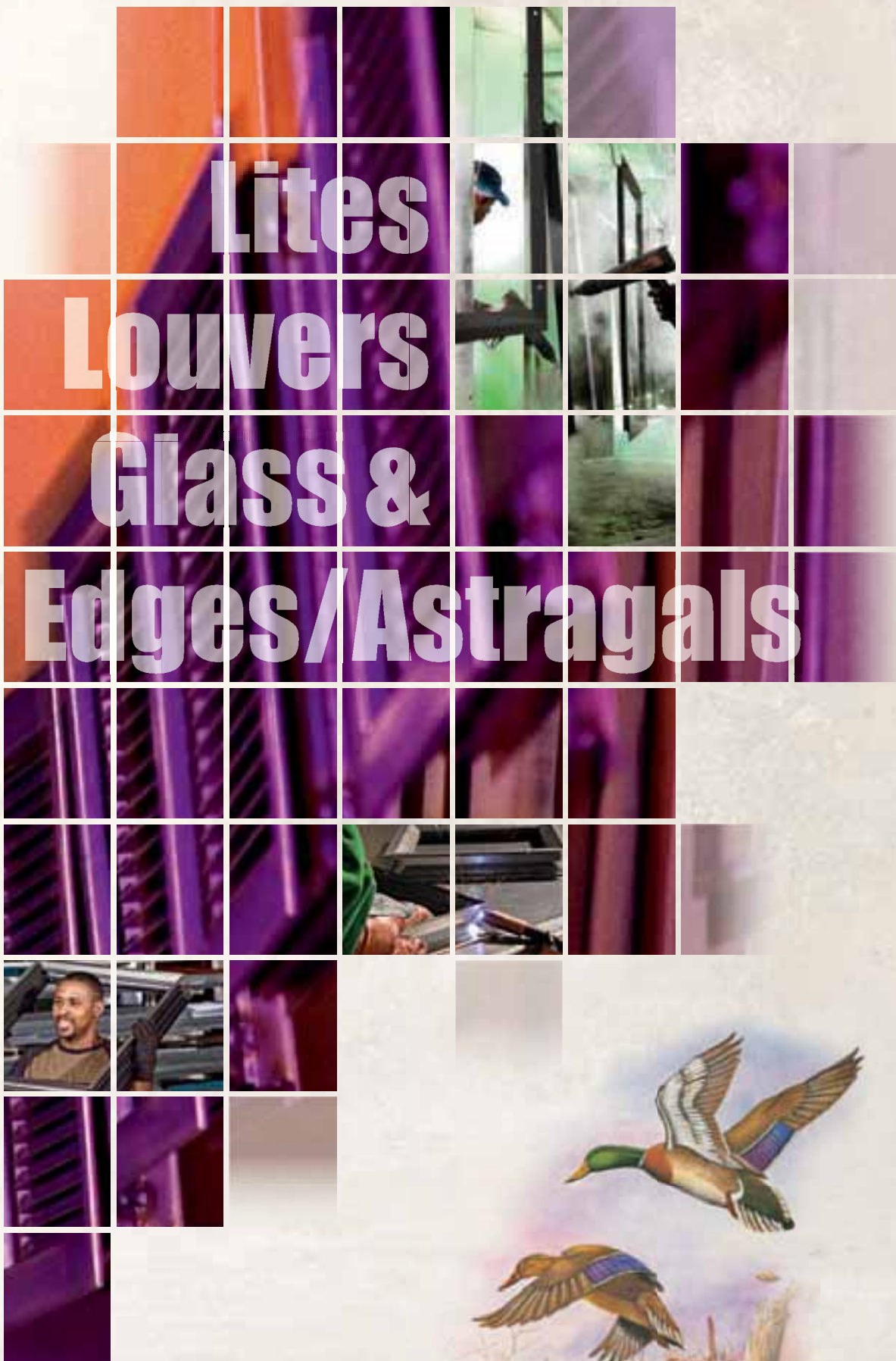



## Symbols/Legend



**POSITIVE PRESSURE UL10C LISTED;** complies with IBC, NFPA 80 and NFPA 252 for use on Positive Pressure Steel fire doors and Wood type Fire doors rated up to 90 minutes.



**UL10B and CAN4-S104-80M LISTED;** complies with NFPA 80 and NFPA 252 for use on Steel fire doors and Wood type fire doors rated up to 90 minutes.

## Materials

Lite Kits are available in Cold Rolled Steel, Galvanneal Steel, and Stainless Steel (type 304). Louvers are available in Cold Rolled Steel, Galvanneal Steel, and Aluminum Alloy 6063-T5. Glass options include Wired, Safety Wired, Glass Ceramic, Tempered, Insulated and Polycarbonate. Glazing Tape options include Butyl Rubber, Closed Cell PVC, and Intumescent.

## Powder Coat Finish

The standard finish for each product is indicated on the catalog page and in the price list and will be provided unless an optional finish is indicated. The following color options can be provided on any Lite Kit, Louver, Metal Edge & Astragal, Threshold or Gasketing with metal retainer:

(GPZ) Gray Primer	(BPR) Beige Primer (matches Steelcraft)
(DKB) Dark Bronze	(PTY) Putty (matches Anemostat Beige)
(T) Tan	(CAB) California Bronze (matches Anemostat)
(GBL) Gloss Black	(W) White
(MBL) Matte Black	(B) Brass (Gold)
(TBL) Textured Black	(WB) Walnut Brown (matches Timely Browntone)
(ASL) Aluminum Silver	(MW) Magnolia White (matches Timely Western White)

Custom colors and color matching available – Consult customer service for details

**Corrosion Resistant Sealer:** A polymeric green seal (non-chrome) corrosion resistance extender is applied under all NGP powder coat finishes. Laboratory salt spray tests prove a dramatic increase in corrosion resistance on steel products with this sealer applied to the metal prior to the powder coat finish.

**Salt Spray Test Results:** Steel lite kits with NGP's corrosion resistant sealer and powder coat finish withstood 1,248 hours without failing. This is 2 1/2 times longer than the protection provided by powder coating only.

## Zinc Electro-Plating

Available on steel lite kits and louvers for extra corrosion resistance; recommended for exterior, wet areas, and coastal salt air locations. Zinc electro-plating will be applied prior to the powder coat finish. Specify on order "Zinc EL-Plate" and powder coat color desired.

## How to Order

<u>Quantity</u>	<u>Model#</u>	<u>Finish</u>	<u>Cut-out Size</u> (width x height)	<u>Options</u>
Example: 10	L-FRA100-SP	DKB	24"x30"	for 1" thick glass

**Lite Kit, Louver, Glass & Glazing Tape Index:**

<u>Model</u>	<u>Lite Kits</u>	<u>Page</u>
L-CVFM-SS	Stainless Steel	L16
L-FRA100	Low Profile	L5
L-FRA100-RD	Round Low Profile	L19
L-FRA100-SP	Low Profile Special Glass or Door Thickness	L6-L7
L-GLF100	Self-Attaching	L8
L-GLF100-SP	Self-Attaching Special Glass or Door Thickness	L10-L11
L-GLF100-SP-TB	Thru-Bolted Special Glass or Door Thickness	L12
L-GLF100-TB	Thru-Bolted	L12
L-SG100	Security Grille	L13, L15
L-SG100-TB	Security Grille Thru-Bolted	L14-L15
L-VGLF-MD, MDL	Security Grille with Privacy Panel	L17
L-VGLF-OG	Security Glass with Privacy Panel	L18
L-VGLF-PZ	Security Glass	L16
L-VGLF-SF	Security Grille with Privacy Panel	L18
L-VGLF-WD	Security Glass with Privacy Panel	L17
Options: G2-G24 False Mullion		L9

<u>Model</u>	<u>Louvers</u>	<u>Page</u>
L-75-A, B, BF	Dark Room	L24
L-A700-A, B, BF, C	Aluminum	L23
L-700-A, B, BF, C	Steel - Adjustable 1 3/8" to 2 1/4" doors	L21
L-700RX	Steel Self-Attaching	L20
L-1900	Fusible Link	L22
L-VRSG-2	Security Grille	L24
L-VRSG-3	Security Grille (Both sides)	L24

**Lite Kit and Louver Fasteners L31**

<u>Model</u>	<u>Glass</u>	<u>Page</u>
Pyran® F	Filmed Safety Ceramic	L26
Pyran® L	Laminated Safety Ceramic	L26
SuperLite™ 1	Safety Tempered (20 minute)	L27
SuperLite™ 1-W	Safety Wired	L25
	Polycarbonate	L29
	Tempered	L29
	Insulated Tempered	L29
	Wired	L28

<u>Model</u>	<u>Glazing Tape</u>	<u>Page</u>
GT-16	1/16" Thick Butyl Rubber	L30
GT-116	1/16" Thick Closed Cell PVC Foam	L30
GT-118	1/8" Thick Closed Cell PVC Foam	L30
GT-132	1/32" Thick Closed Cell PVC Foam	L30
GT-9800	1/16" Thick Intumescent	L30
L-Clips	H.M Door Reinforcement	L30

**Metal Edges and Astragals**

540 .....	L33	552 .....	L34	563 .....	L34
541 .....	L33	553 .....	L34	565 .....	L32
542 .....	L33	555 .....	L33	570 .....	L33
543 .....	L33	560 .....	L34	572 .....	L33
545 .....	L33	561 .....	L34	574 .....	L33
550 .....	L34	562 .....	L34	575 .....	L32
551 .....	L34				



## Lite Kit Technical Information

**Fire-Rated Lite Kits:** Lite Kits installed in fire-rated doors require fire-rated glass and glazing tape. Refer to pages L25-L28 for fire-rated glass and maximum sizes for fire-rated applications.

**Impact Safety Rated Glass requirements:** IBC requires all individual glazed areas in swinging doors to be impact safety-rated to comply with the CPSC 16CFR 1201 Category I or II. Refer to page L31 for detailed information regarding compliance on fire-rated doors.

**Accessibility Standard Compliance:**

ICC/ANSI A117.1-2003 Standard for Accessible and Usable Buildings and Facilities, section 404.2.10 requires that the bottom of the glass panel in a vision lite is 43” maximum above the floor. An exception for vision lites with the lowest part more than 66” above the floor are not required to comply.

## Louver Technical Information

Steel louvers over 46” wide and aluminum louvers over 36” wide must be furnished as two louver cores mounted in one louver frame with a mullion in between. All Louvers over 64” or more in height will be furnished as two louver cores mounted in one frame with a mullion in between.

## LEED Green Building

The LEED (Leadership in Energy and Environmental Design) Green Building Rating System® is a national standard for developing high-performance, sustainable buildings developed by the U. S. Green Building Council.

Our products contain the following percentages of recycled materials qualifying for LEED® MR Credit 4; Recycled content:

	Post Consumer Recycled %	Pre-Consumer Recycled %
Lite Kits & Louvers (Steel)	75%	0%
Aluminum Louvers	75%	0%
Metal Edge/Astragal sets (Steel)	70%	0%

NGP Lite Kits and Louvers are factory finished using powder coating technology which does not produce volatile organic compounds (VOCs) in the application process, and does not give off VOCs in use on the job or when recycled.

Contact us for a current letter containing LEED qualification information for all our products.

## Buy American Act

Over 99% of our products are produced in the United States as a domestic construction material, as defined in the Buy American Act (BAA) of March 1933 and amended by the Buy American Act of 1988; and additionally qualify as manufactured products produced in the United States as manufactured goods, as defined in OMB Guidance (176.140; 176.70(a) (2) (ii); 176.160, complying with the Federal American Recovery Reinvestment Act, ARRA-2009. Contact us for a BAA or ARRA certificate for your project.

## L-FRA100

### Low Profile Self-Attaching Lite Kit for 1 3/4" Door with 3/16", 1/4" or 5/16" Glass

- 18 ga. cold rolled steel
- Mitered and welded corners
- Welded reinforcing clips at corners
- Counter-sunk mounting screw-holes
- #8 x 1-1/2" Phillips head SMS
- Available in uneven and fractional sizes
- Powder coat finish = (GPZ) Gray Primer

#### AVAILABLE OPTIONS

- Powder coat color options - see page L2
- Torx Security Screws
- Galvanneal - A40 Steel
- Zinc electro-plating
- Glass & Glazing tape (Pages L25-L30)
- Lead lining - .030" thick



#### Fire-rating Information:

- Pyran® Platinum F, SuperLite™1, and SuperLite™1-W require closed cell PVC foam glazing tape like NGP GT-116, GT-118, or GT-132.
- Fire-rated 1/4" wired glass:
  - 20 min. requires closed cell PVC foam glazing tape like NGP GT-116, GT-118, or GT-132.
  - 45, 60, 90 min. requires NGP GT-9800 or 3M GIS intumescent glazing tape.

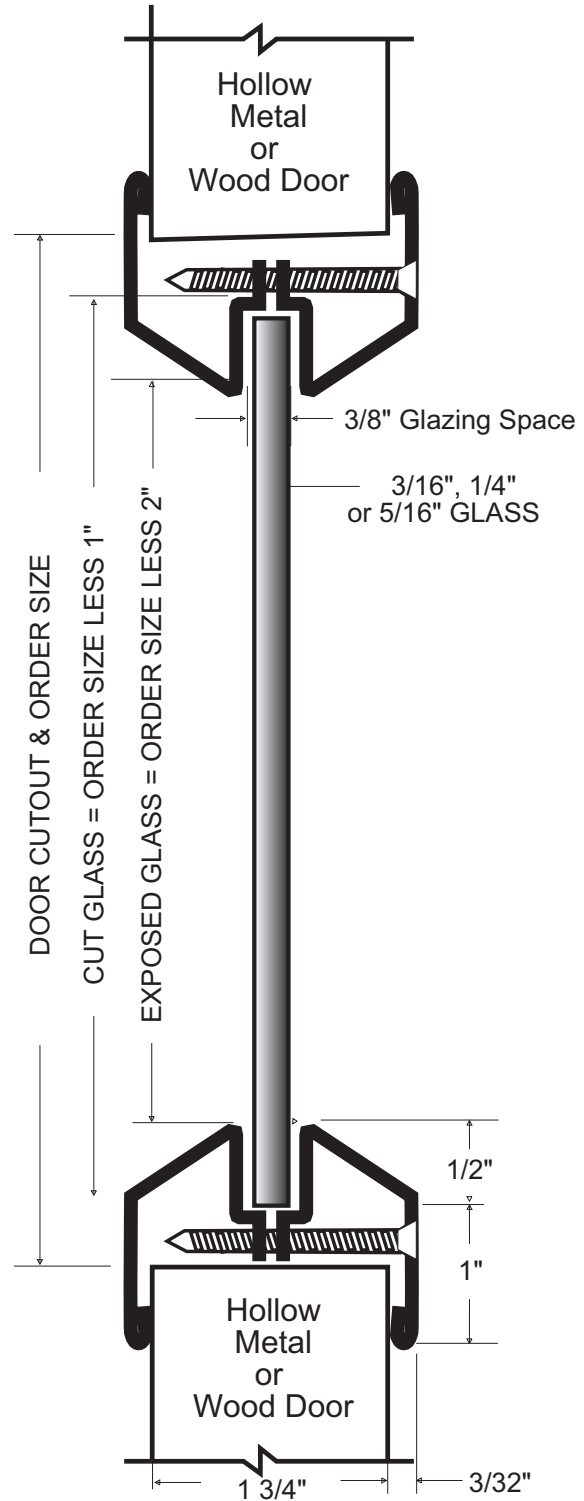
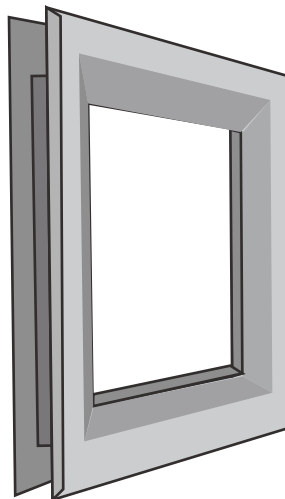

Designed for use on 1 3/4" thick doors manufactured within door industry tolerance of +/- 1/16".

## L-FRA100-SP

### Low Profile Self-Attaching Lite Kit for Variable Door and/or Glass Thickness

- 18 ga. cold rolled steel
- Mitered and welded corners
- Welded reinforcing clips at corners
- Counter-sunk mounting screw-holes
- #8 Phillips head SMS
- Available in uneven and fractional sizes
- Powder coat finish = (GPZ) Gray Primer

#### Required Information

- Specify glass thickness on order.
- Specify door thickness on order if other than 1 3/4"

#### AVAILABLE OPTIONS

- Powder coat color options - see page L2
- Torx Security Screws
- Galvanneal - A40 Steel
- Zinc electro-plating
- Glass & Glazing tape (Pages L25-L30)
- Lead lining - .030" thick



#### Fire-rating Information:

- Pyran® Platinum F, Pyran® Platinum L, SuperLite™ 1, and SuperLite™ 1-W require closed cell PVC foam glazing tape like NGP GT-116, GT-118, or GT-132.
- Fire-rated 1/4" wired glass:
  - 20 min. requires closed cell PVC foam glazing tape like NGP GT-116, GT-118, or GT-132.
  - 45, 60, 90 min. requires NGP GT-9800 or 3M GIS intumescent glazing tape.

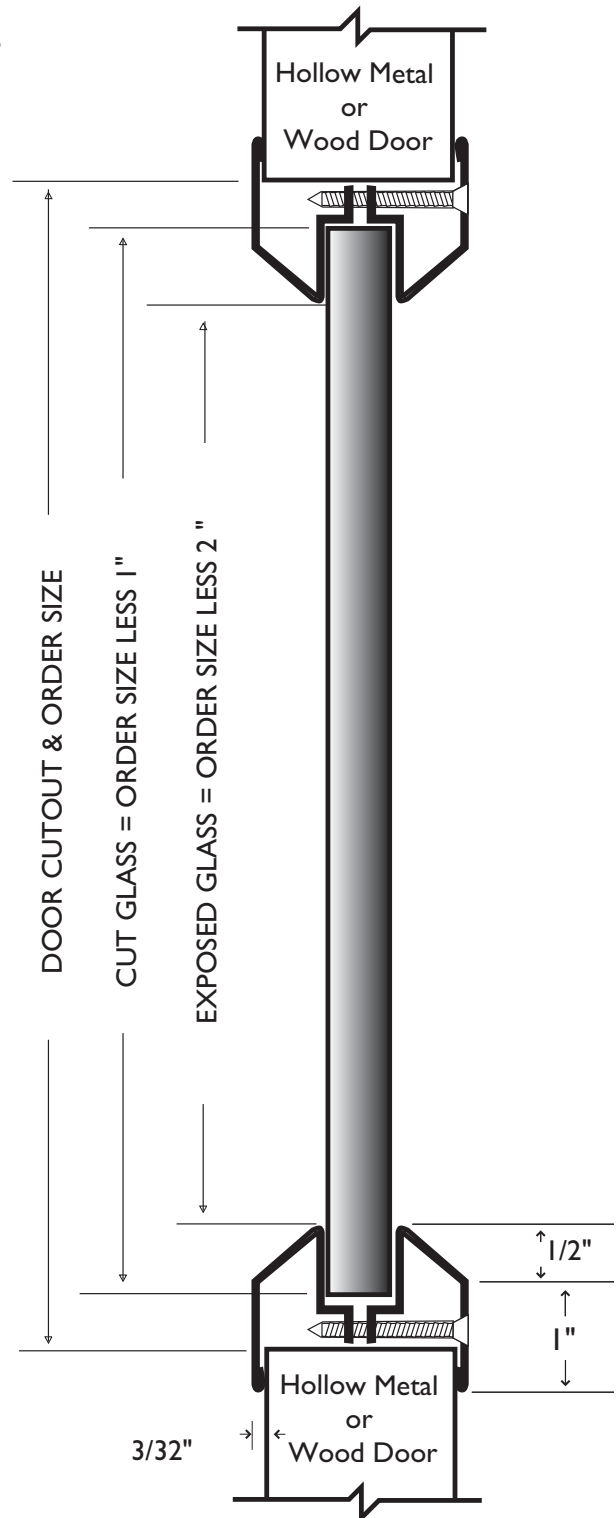

## L-FRA100-SP Glass and Door Combinations

Details shown are for 1 3/4" door thickness.

Only configurations shown are available

\* indicates that thicker glazing tape is required

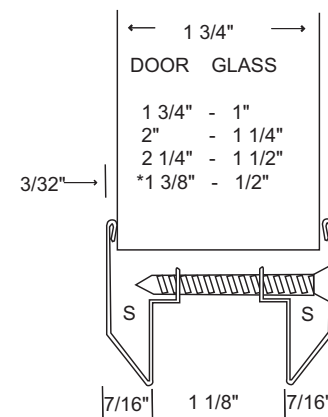
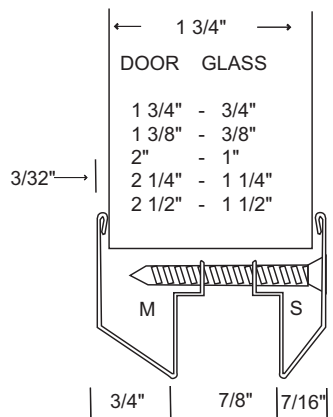
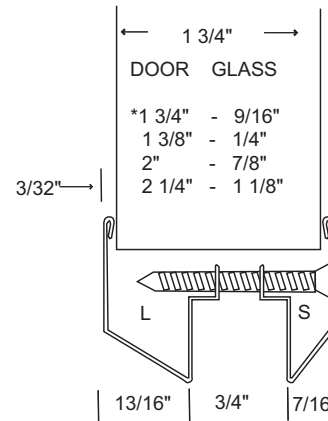
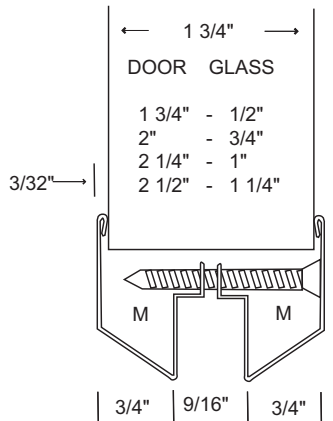
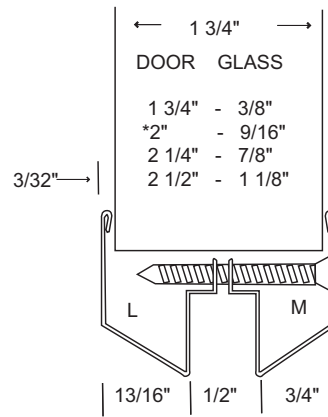
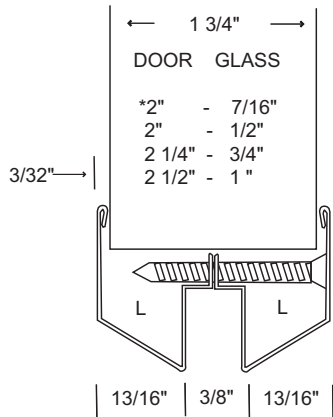

## L-GLF100

### Self Attaching Lite Kit for 1 3/4" Door with 3/16", 1/4", or 5/16" Glass

- 18 ga. cold rolled steel
- Mitered and welded corners
- Welded reinforcing clips at corners
- Countersunk mounting screw-holes interior side
- #6 x 1-3/4" Phillips Truss Head SMS
- Powder coat finish = (GPZ) Gray Primer

#### AVAILABLE OPTIONS

- Powder coat color options - see page L2
- False mullion bars (page L9)
- Torx Security Screws
- Zinc electro-plating
- Galvanneal - A40 Steel
- Glass & Glazing tape (Pages L25-L30)
- Lead lining - .030" thick



#### Fire-rating Information:

- Pyran® Platinum F, SuperLite™ 1, and SuperLite™ 1-W require closed cell PVC foam glazing tape like NGP GT-116, GT-118, or GT-132.
- Fire-rated 1/4" wired glass:  
20 min. requires closed cell PVC foam glazing tape like NGP GT-116, GT-118, or GT-132.  
45, 60, 90 min. requires NGP GT-9800 or 3M GIS intumescent glazing tape.

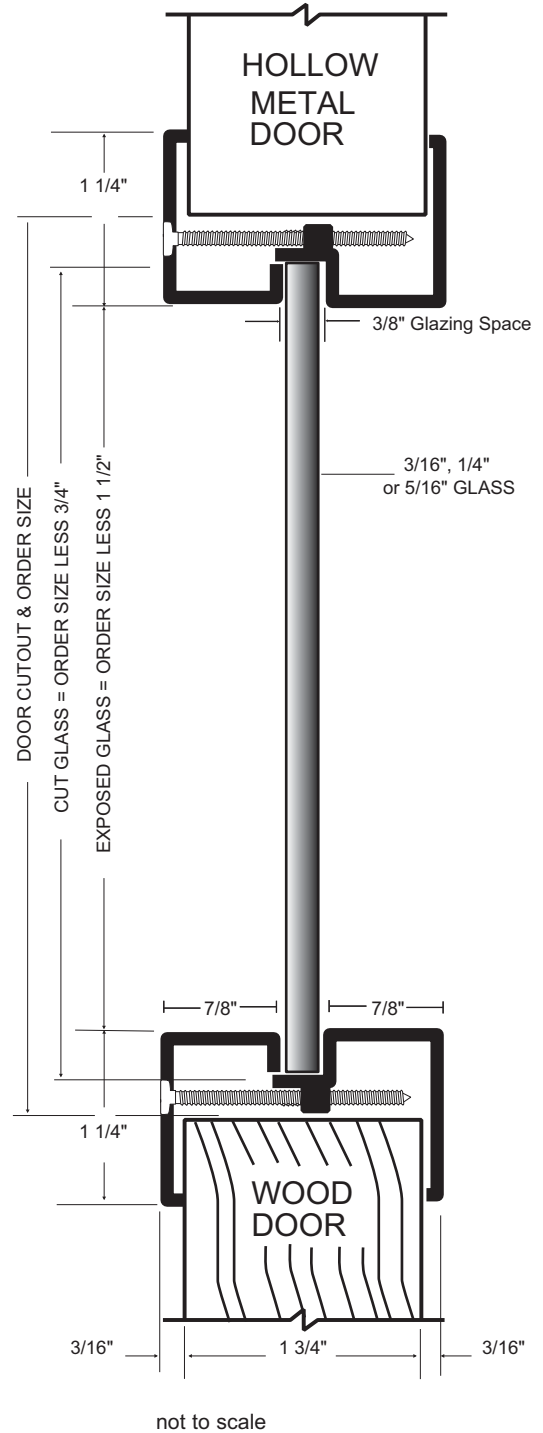
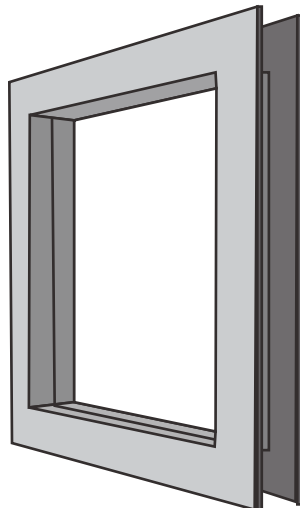

Designed for use on 1 3/4" thick doors manufactured within door industry tolerance of +/- 1/16".



## False Mullion Lite Kits

- 1" wide steel channel
- Fits L-GLF100, L-GLF100-SP, L-GLF100-TB, L-GLF100-SP-TB, L-SG100, L-SG100-TB
- Mullion bars welded into both sides of Lite Kit
- Finished to match Lite Kit

### AVAILABLE OPTIONS

- \* Zinc electro-plating

### To Order

Specify Lite Kit x G# (i.e.: G2, G3, G4 etc.)

If other than as illustrated, provide detail & suffix G-SP

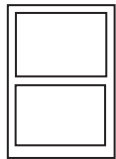
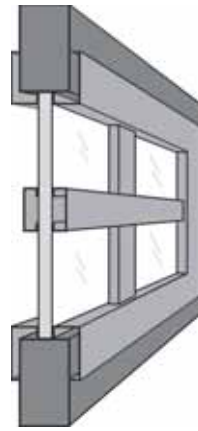

G2  
(1 Bar)

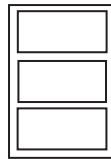

G3  
(2 Bars)

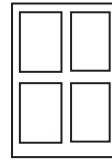

G4  
(2 Bars)

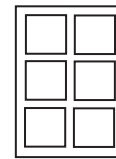

G6  
(3 Bars)

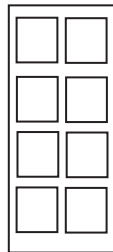

G8  
(4 Bars)

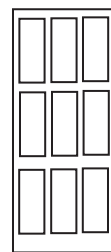

G9  
(4 Bars)

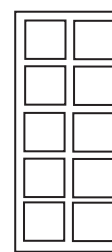

G10  
(5 Bars)

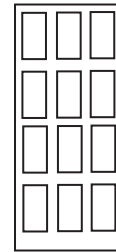

G12  
(5 Bars)

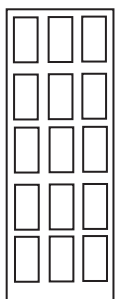

G15  
(6 Bars)

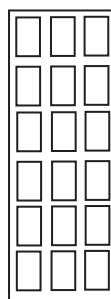

G18  
(7 Bars)

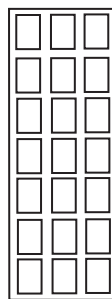

G21  
(8 Bars)

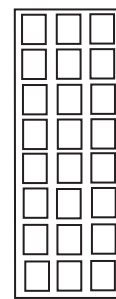

G24  
(9 Bars)

## L-GLF100-SP

### Self Attaching Lite Kit for Variable Door and/or Glass Thickness

- 18 ga. cold rolled steel
- Mitered and welded corners
- Welded reinforcing clips at corners
- Countersunk mounting screw-holes interior side
- #6 Phillips Truss Head SMS
- Powder coat finish = (GPZ) Gray Primer

#### Required Information

- Specify glass thickness on order
- Specify door thickness on order if other than 1-3/4"

#### AVAILABLE OPTIONS

- Powder coat color options - see page L2
- False mullion bars (Page L9)
- Torx Security Screws
- Zinc electro-plating
- Galvanneal - A40 Steel
- Glass & Glazing tape (Pages L25-L30)
- Lead lining - .030" thick lead



#### Fire-rating Information:

- Pyran® Platinum F, Pyran® Platinum L, SuperLite™ 1, and SuperLite™ 1-W require closed cell PVC foam glazing tape like NGP GT-116, GT-118, or GT-132.
- Fire-rated 1/4" wired glass:  
20 min. requires closed cell PVC foam glazing tape like NGP GT-116, GT-118, or GT-132.  
45, 60, 90 min. requires NGP GT-9800 or 3M GIS intumescent glazing tape.

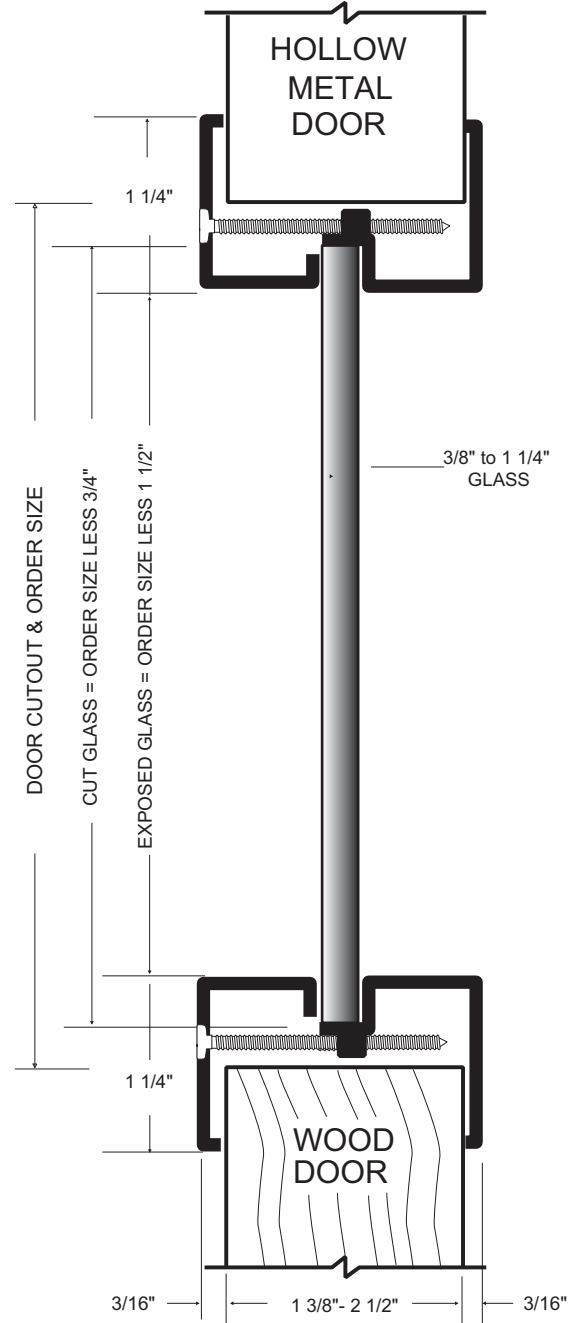
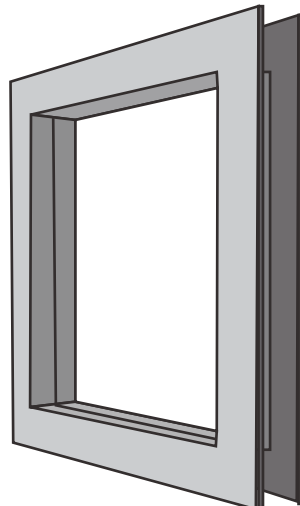

not to scale

## L-GLF100-SP and L-GLF100-SP-TB Glass and Door Combinations

Details shown are for 1-3/4" door thickness

Only Configurations shown are available

\*indicates that thicker glazing tape is is required

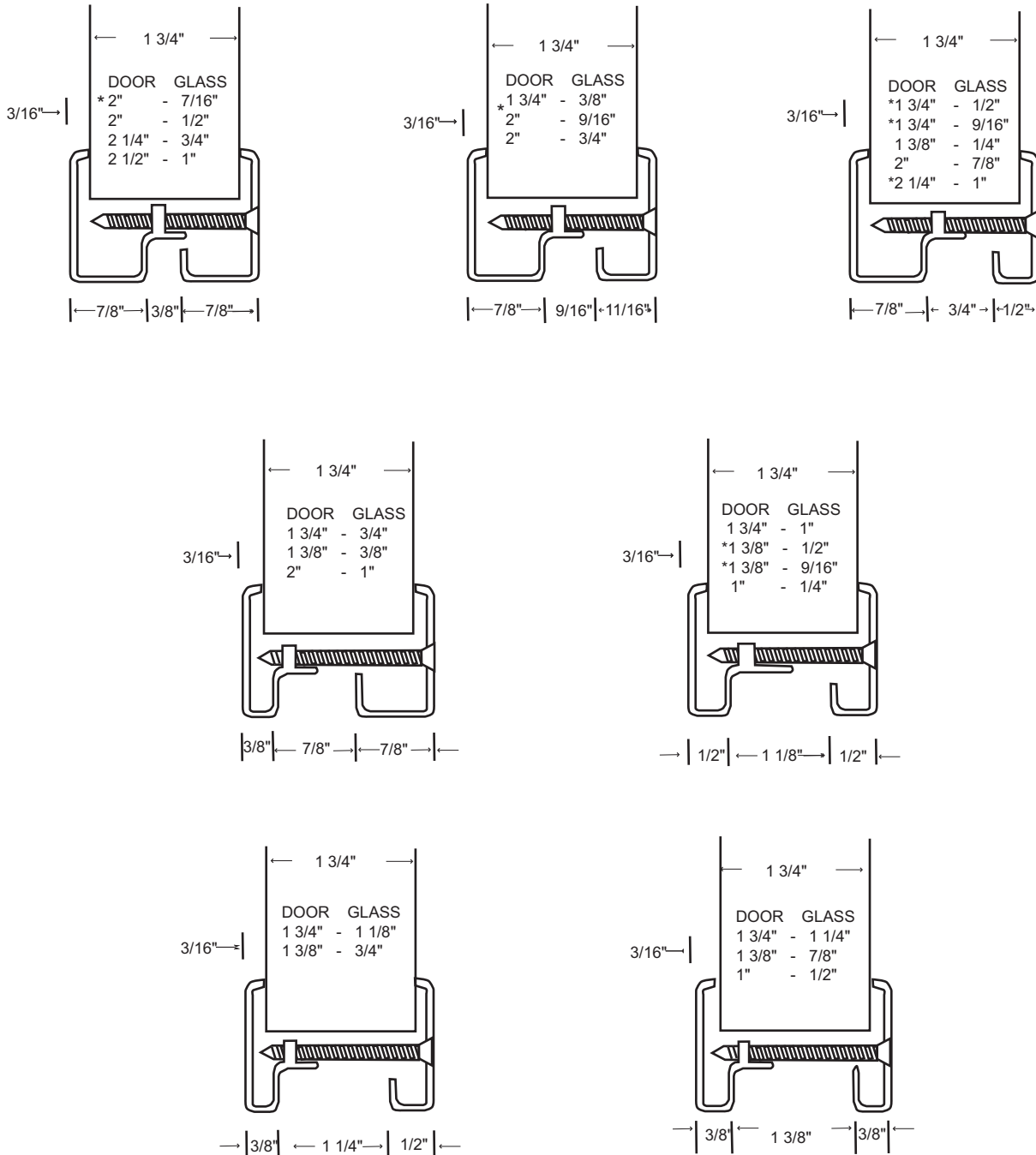

## L-GLF100-TB

### Thru-bolted Lite Kit for 1-3/4" Doors with 3/16", 1/4", or 5/16" Glass

- 18 ga. cold rolled steel
- Mitered and welded corners
- Welded reinforcing clips at corners
- Countersunk mounting screw-holes
- Thru-bolts for 1-3/4" door
- Powder coat finish - (GPZ) Gray Primer

#### AVAILABLE OPTIONS

- Powder coat color options - see page L2
- False Mullion bars (Page L9)
- #8 x 3/4" Phillips head SMS both sides (specify "pack with screws")
- Torx Security screws both sides
- Zinc electro-plating
- Galvanneal - A40 Steel
- Glass & Glazing tape (Pages L25-L30)
- Lead lining - .030" thick

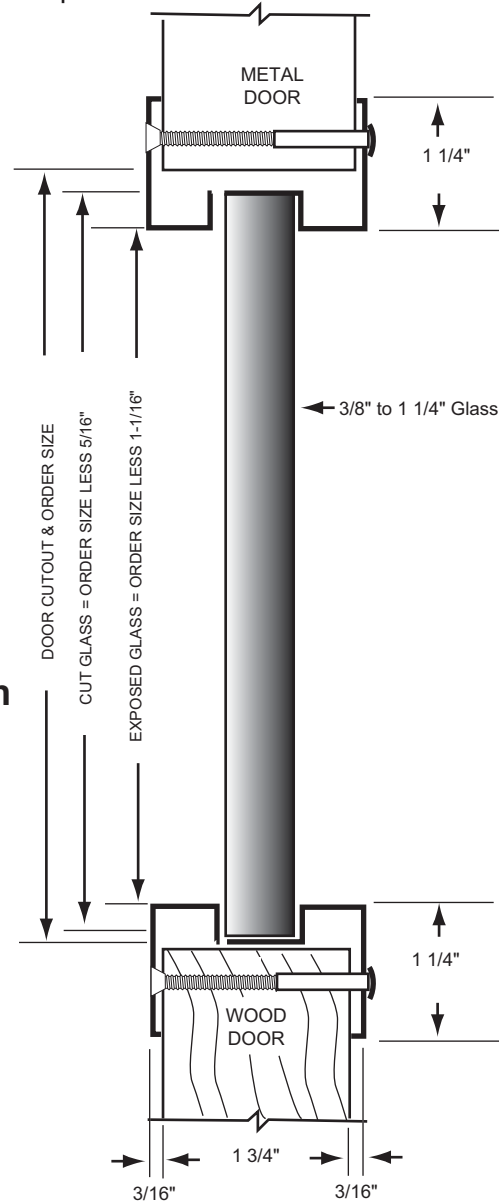

Designed for 1 3/4" thick Doors manufactured within door industry tolerance of +/- 1/16"

not to scale

## L-GLF100-SP-TB

### Thru-bolted Lite Kit for 1-3/4" doors, with Variable Glass Thickness 3/8" to 1-1/4"

- 18 ga. cold rolled steel
- Mitered and welded corners
- Welded reinforcing clips at corners
- Countersunk mounting screw-holes
- Thru-bolts for 1-3/4" door
- Powder coat finish - (GPZ) Gray Primer
- Hurricane/Windstorm Florida Product Approval FL10144

**Required Information:** Specify Glass thickness

#### AVAILABLE OPTIONS

- Powder coat color options - see page L2
- False Mullion bars (Page L9)
- Torx Security screws both sides
- Zinc electro-plating
- Galvanneal - A40 steel
- Glass & Glazing tape (Pages L25-L30)
- Lead lining - .030" thick



**Fire-rating Information for all products this page:**

- Pyran® Platinum F, Pyran® Platinum L, SuperLite™ 1, and SuperLite™ 1-W require closed cell PVC foam glazing tape like NGP GT-116, GT-118, or GT-132.
- Fire-rated 1/4" wired glass: 20 min. requires closed cell PVC foam glazing tape like NGP GT-116, GT-118, or GT-132.  
45, 60, 90 min. requires NGP 9800 or 3M GIS intumescent glazing tape.

## L-SG100

### Self Attaching Security Grille Lite Kit for Variable Door and/or Glass Thickness

- 18 ga. cold rolled steel
- 16 ga. steel 3/4" x 3/4" security grille welded in both sides
- Mitered and welded corners
- Welded reinforcing clips at corners
- Countersunk mounting screw-holes interior side
- #6 Phillips truss head screws
- Powder coat finish - (GPZ) Gray Primer

#### Required Information

- Specify glass thickness on order
- Specify door thickness on order if other than 1-3/4" (See page L15 for available sizes)

#### AVAILABLE OPTIONS

- Powder coat color options - see page L2
- False mullion bars (Page L9)
- Torx security screws
- Zinc electro-plating
- Galvanneal - A40 Steel
- Glass & glazing tape (Pages L25-L30)
- Lead lining - .030" thick



#### Fire-rating Information:

- Pyran® Platinum F, Pyran® Platinum L, SuperLite™ 1, and SuperLite™ 1-W require closed cell PVC foam glazing tape like NGP GT-116, GT-118, or GT-132.
- Fire-rated 1/4" wired glass: 20 min. requires closed cell PVC foam glazing tape like NGP GT-116, GT-118, or GT-132. 45, 60, 90 min. requires NGP 9800 or 3M GIS intumescent glazing tape.

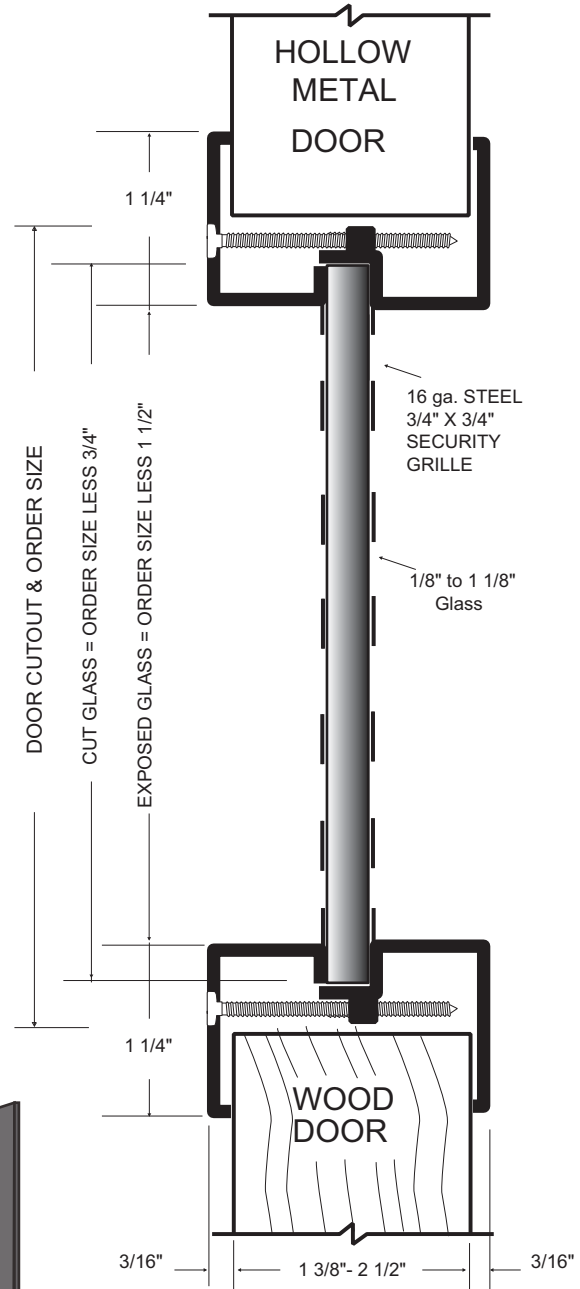
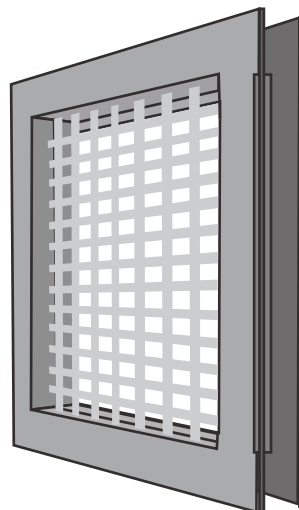

not to scale

## L-SG100-TB

### Thru-Bolted Security Grille Lite Kit For 1 3/4" Doors with Variable Glass Thickness

- 18 ga. cold rolled steel
- 16 ga. steel 3/4" x 3/4" security grille welded in both sides
- Mitered and welded corners
- Welded reinforcing clips at corners
- Countersunk mounting screw-holes
- Thru-bolts for 1-3/4" door
- Powder coat finish - (GPZ) Gray Primer

#### Required Information;

- Specify glass thickness on order  
(See page L15 for available sizes)

#### AVAILABLE OPTIONS

- Powder coat color options - see page L2
- False mullion bars (Page L9)
- Torx security screws both sides
- Zinc electro-plating
- Galvanneal - A40 Steel
- Glass & Glazing tape (Pages L25-L30)
- Lead lining - .030" thick



#### Fire-rating Information:

- Pyran® Platinum F, Pyran® Platinum L, SuperLite™ 1, and SuperLite™ 1-W require closed cell PVC foam glazing tape like NGP GT-116, GT-118, or GT-132.
- Fire-rated 1/4" wired glass: 20 min. requires closed cell PVC foam glazing tape like NGP GT-116, GT-118, or GT-132.

45, 60, 90 min. requires NGP GT-9800 or 3M GIS intumescent glazing tape.

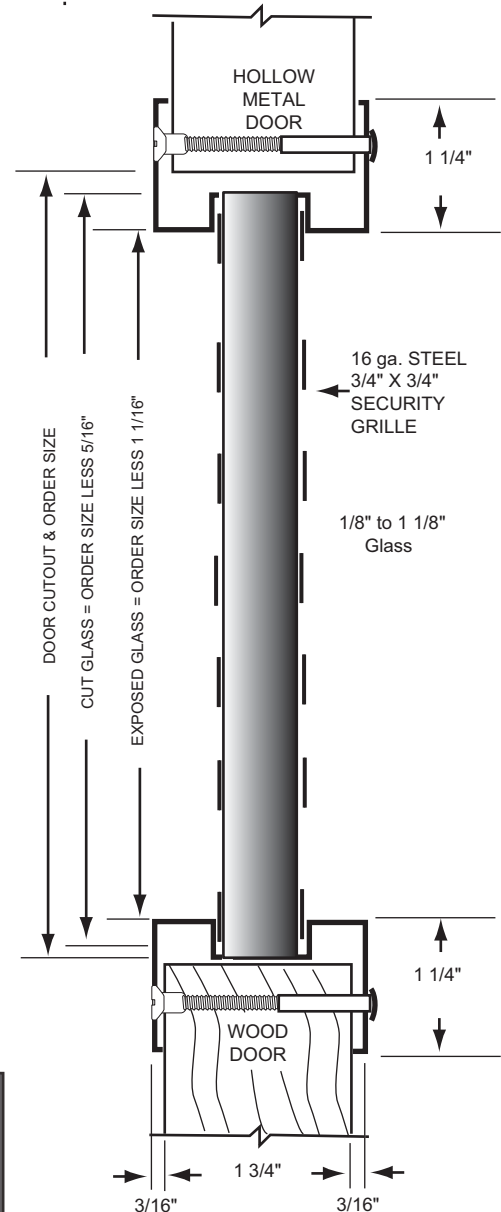
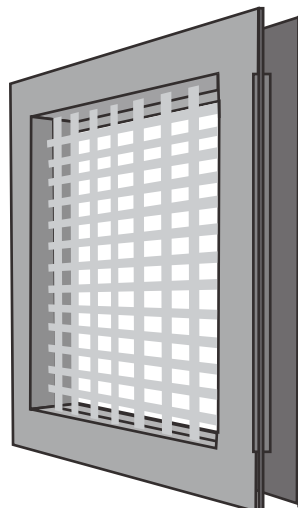

not to scale

## L-SG100 and L-SG100-TB Glass and Door Combinations

Details shown are for 1 3/4" door thickness

Only Configurations shown are available

\*indicates that thicker glazing tape is required

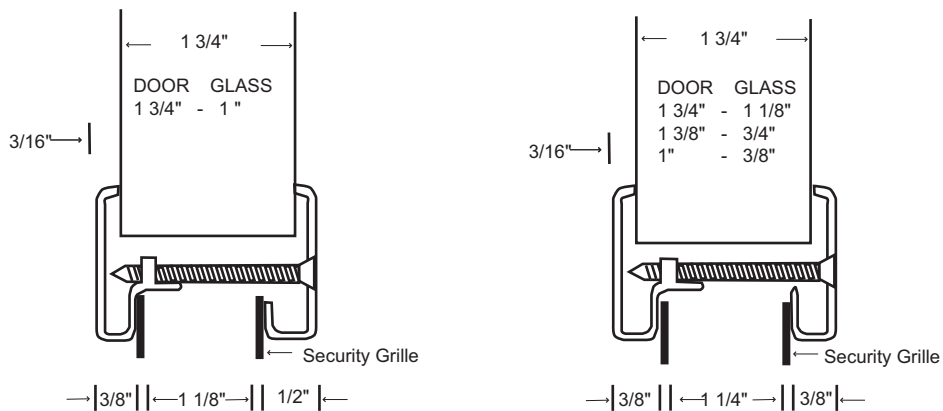
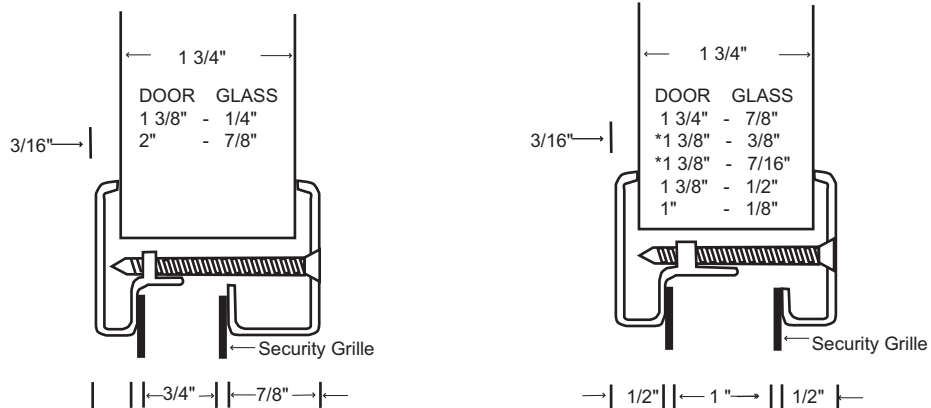
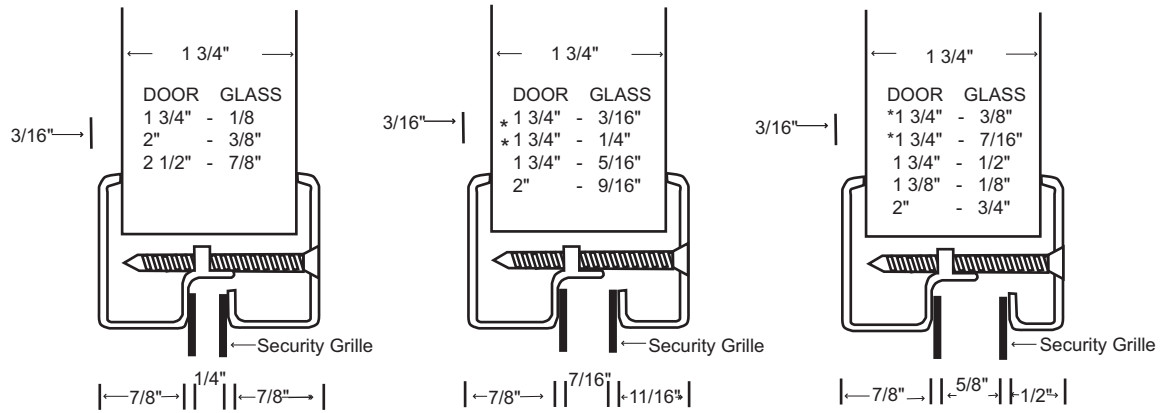

## L-CVFM-SS

### Stainless Steel Lite Kit

- 20 ga. Type 304 stainless steel
- Mitered and welded corners
- For 1-3/4" door; accepts 3/16", 1/4" or 5/16" glass
- Countersunk mounting screw-holes
- #8 x 1 3/4" Phillips head SMS
- #4 satin finish

#### Available Options

- Powder coat finish - see page L2
- Torx Security Screws
- Glass & Glazing tape (Pages L25-L30)
- Lead Lining - .030" thick

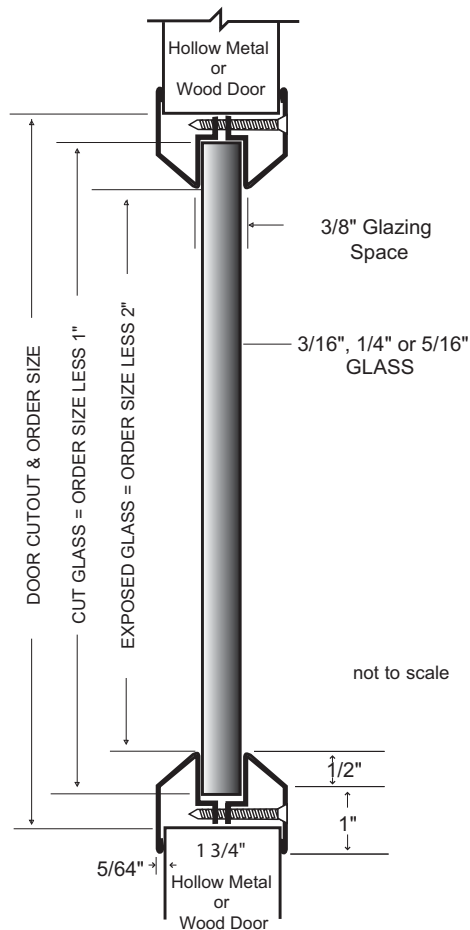

## L-VGLF-PZ (9" X 9")

### Security Lite Kit



- 18 ga. cold rolled steel
- Mitered and welded corners
- For 1-3/4" hollow metal/wood doors
- 1/2" thick high impact polycarbonate plastic
- No exposed fasteners on outside of door
- Low-profile frame
- 6"x 6" exposed glass size
- #8 x 1" Oval head TEK screws
- 2.8 oz. Silicone sealant included
- Powder coat finish - (GPZ) Gray Primer

#### Available Options

- Powder coat color options - see page L2
- Torx security screws
- Zinc electro-plating

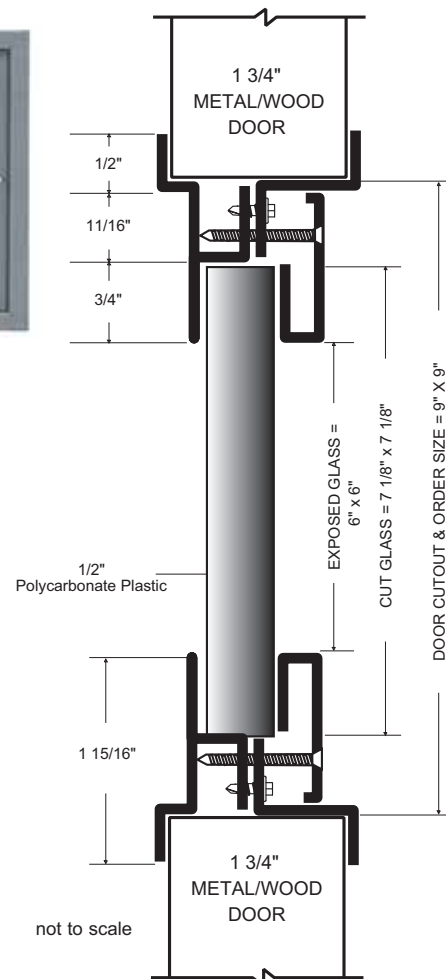



**L-VGLF-MD (9" X 9"),  
L-VGLF-MDL (12" X 12")  
Security Lite Kits**

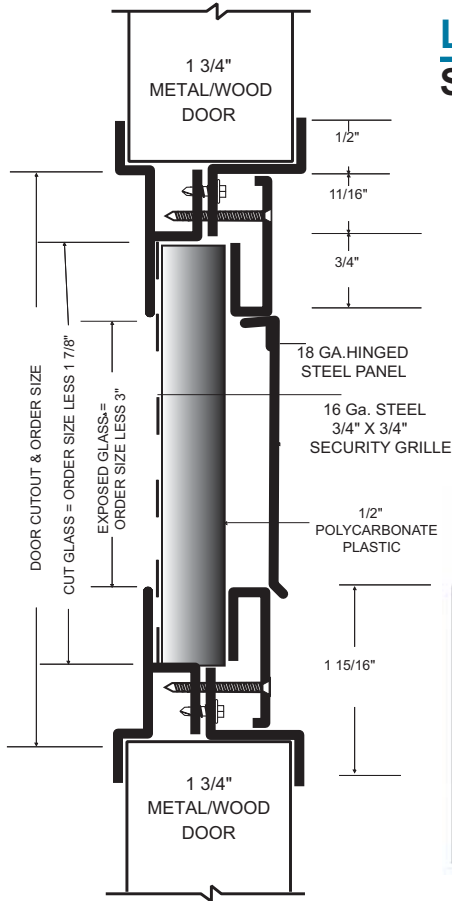

- 18 ga. cold rolled steel
- Mitered and welded corners
- For 1 3/4" hollow metal/wood doors
- 1/2" thick high impact polycarbonate plastic
- 16 ga. steel 3/4" x 3/4" security grille
- 18 ga. steel hinged panel
- No exposed fasteners on outside of door
- Low-profile frame
- 6"x 6" exposed glass size on L-VGLF-MD
- 9"x 9" exposed glass size on L-VGLF-MDL
- #8 x 1" Oval head TEK screws
- 2.8 oz. Silicone sealant included
- Powder coat finish - (GPZ) Gray Primer

**Available Options**

- Powder coat color options - see page L2
- Torx security screws
- Zinc electro-plating

**L-VGLF-WD (9" X 5")  
Security Lite Kit**

- 18 ga. cold rolled steel
- Mitered and welded corners
- 1 3/4" hollow metal/wood doors
- 1/2" thick high impact polycarbonate plastic
- 18 ga. steel hinged panel
- No exposed fasteners on outside of door
- Low-profile frame
- 6"x 2" exposed glass size
- #8 x 1" Oval head TEK screws
- 2.8 oz. Silicone sealant included
- Powder coat finish - (GPZ) Gray Primer

**Available Options**

- Powder coat color options - see page L2
- Torx security screws
- Zinc electro-plating



not to scale

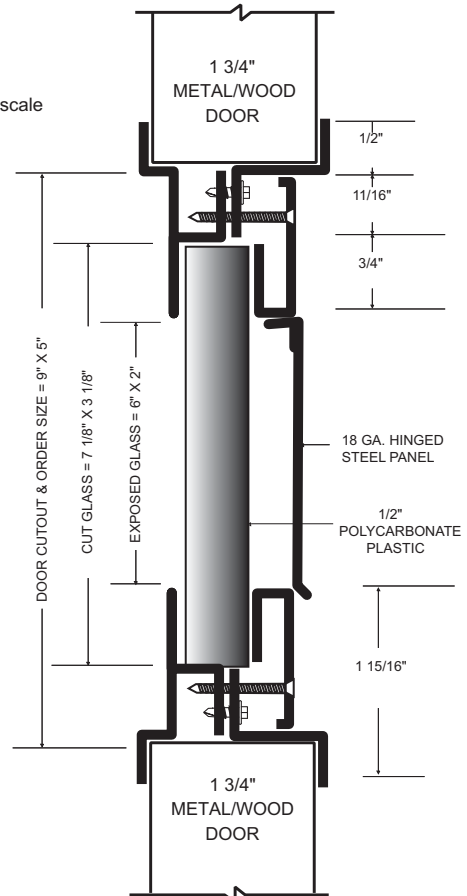

## L-VGLF-OG (9" X 9") Security Lite Kits

- 18 ga. cold rolled steel
- Mitered and welded corners
- For 1 3/4" hollow metal/wood doors
- 1/2" thick high impact polycarbonate plastic
- 18 ga. steel hinged panel
- No exposed fasteners on outside of door
- Low-profile frame
- 6"x 6" exposed glass size
- #8 x 1" Oval head TEK screws
- 2.8 oz. Silicone sealant included
- Powder coat finish - (GPZ) Gray Primer

### Available Options

- Powder coat color options - see page L2
- Torx security screws
- Zinc electro-plating

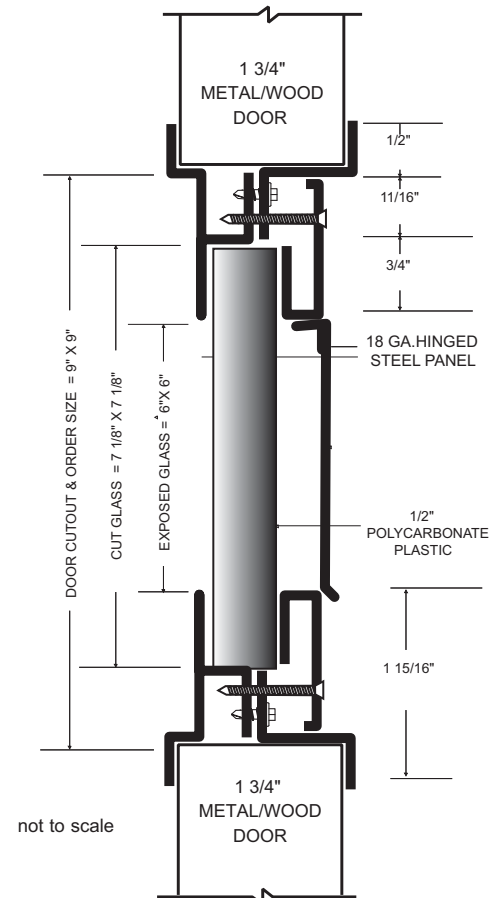

## L-VGLF-SF (11" X 11") Security Lite Kit

- 18 ga. cold rolled steel
- Mitered and welded corners
- For 1 3/4" hollow metal/wood doors
- 1/4" thick high impact polycarbonate plastic
- 16 ga. steel 3/4" x 3/4" security grille
- 18 ga. steel hinged panel with bolt latch
- No exposed fasteners on outside of door
- Low-profile frame
- 8"x 8" exposed glass size
- #8 x 1" Oval head TEK screws
- 2.8 oz. Silicone sealant included
- Powder coat finish - (GPZ) Gray Primer

### Available Options

- Powder coat color options - see page L2
- Torx security screws
- Zinc electro-plating

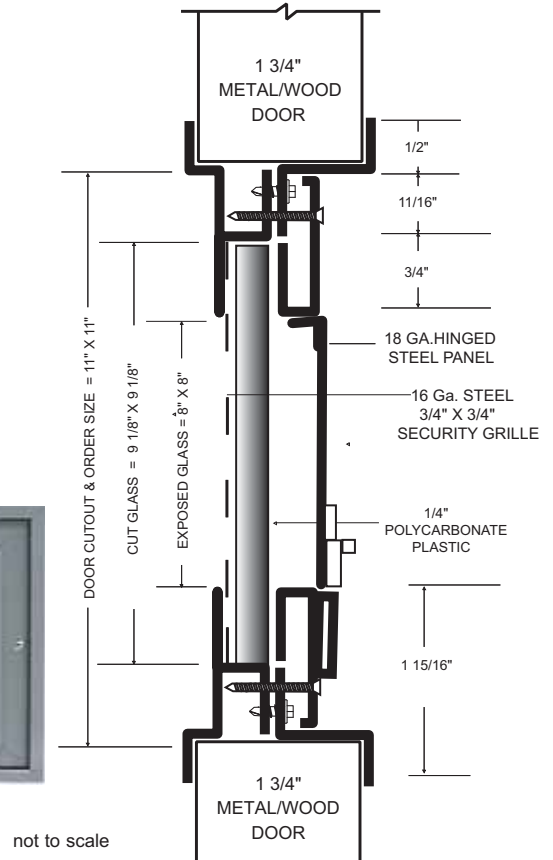

## L-FRA-100-RD

### Round Glass Vision Lite Kit, Self Attaching

- 20 ga. cold rolled steel
- Countersunk mounting screw-holes
- #8 Phillips head SMS
- For 1 3/4" door, accepts 3/16", 1/4", or 5/16" glass
- Putty (beige) finish baked enamel
- Available in 12", 18" and 24" sizes only

#### Available Options

- Powder coat color options - see page L2
- Zinc electro-plating
- Glass & Glazing tape (Pages L25-L30)



#### Fire-rating Information:

- Fire-rated 1/4" wired glass, Pyran® Platinum F, Pyran® Platinum L, Superlite™ 1 and SuperLite™ 1-W require closed cell PVC foam glazing tape like NGP GT-116, GT-118 or GT-132.

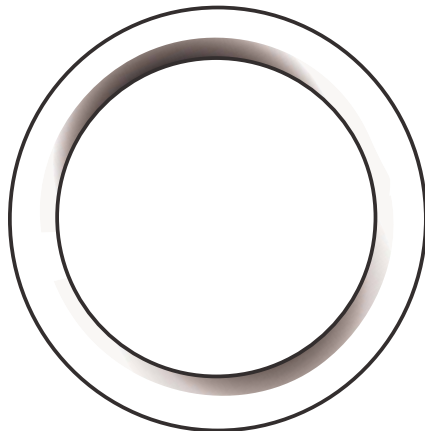

not to scale

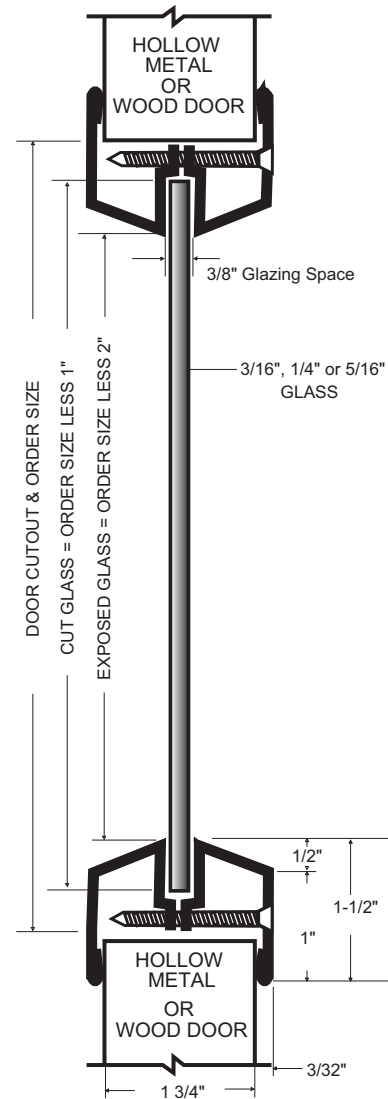

## L-700-RX

### Self Attaching, No Vision Door Louver for 1 3/4" Thick Doors

- 18 ga. cold rolled steel
- Mitered and welded corners
- Welded reinforcing clips at corners
- Inverted "V" design
- Blades 24 ga. steel; hemmed edges
- Counter-sunk mounting screw-holes interior side
- #8 x 3/4" Phillips head SMS
- Available in uneven and fractional sizes
- Matches L-GLF100 series glass frame
- Free area 70%
- Powder coat finish - (GPZ) Gray Primer

#### Available Options

- Powder coat color options - see page L2
- Thru Bolts - specify L-700-RX-TB
- Aluminum Insect screen (installed on exterior side unless requested otherwise)
- Torx Security Screws
- Galvanneal - A40 Steel
- Zinc electro-plating

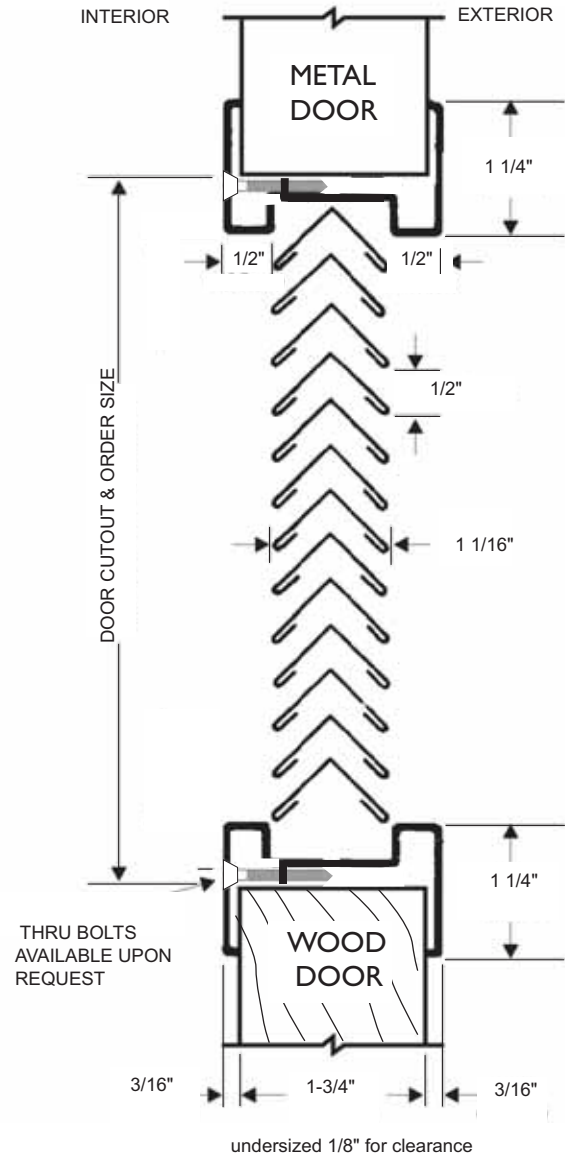
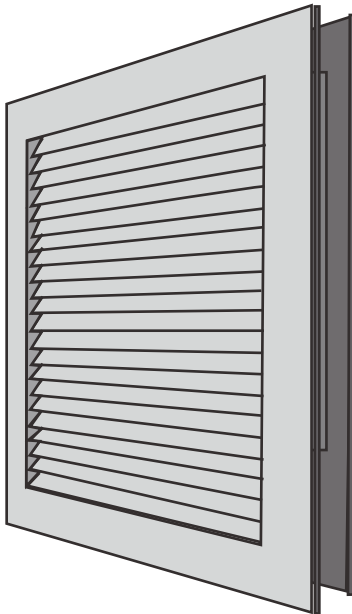

Designed for use on 1 3/4" thick doors manufactured within door industry tolerance of +/- 1/16".

**L-700 SERIES**

**No Vision Door and Partition Louver for 1 3/8", 1 3/4" up to 2 1/4" Thick Doors**

- 20 ga. cold rolled steel frame
- Mitered and welded corners
- Welded reinforcing clips at corners
- Inverted "V" design
- Blades 24 ga. steel; hemmed edges
- Counter-sunk mounting screw-holes
- #8 x 3/4" Phillips head TEK screws
- Available in uneven and fractional sizes
- Powder coat finish - (GPZ) Gray Primer
- Free area 70%

**Available Options**

- Powder coat color options - see page L2
- Thru bolts (TB) for 1-3/4" door when specified
- Aluminum Insect screen (installed on exterior side unless requested otherwise)
- Torx Security Screws
- Zinc electro-plating
- Galvanneal A40 Steel (L-700-A and L-700-C only)

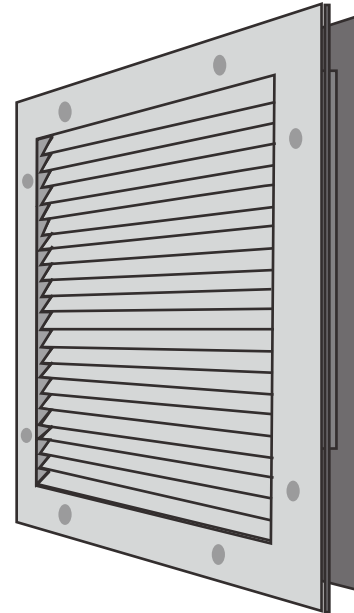

No Vision Door and Partition Louver L-700

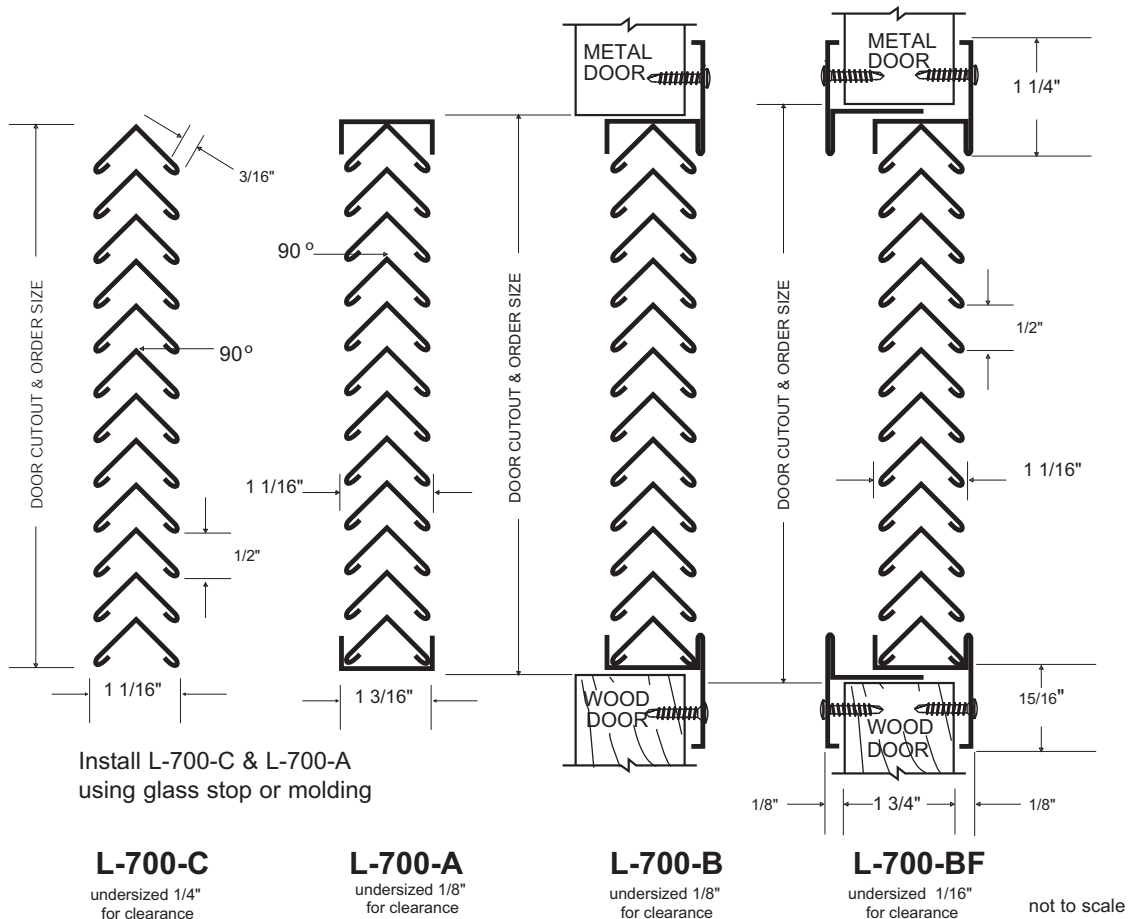



## L-1900

### Fusible Link Louver for 1 3/4" Thick Fire-Rated Doors up to 90 minutes

- Blades close when activated by fire/heat
- 18 ga. cold rolled steel frame
- 18 ga. cold rolled steel adjustable "Z" blades
- Mitered and welded corners
- Stainless Steel Springs
- 165° Fusible link
- Free area 40%
- #8 x 1" Phillips head SMS
- Gray Primer finish

#### Available Options

- Dark Bronze or Putty (Beige) finish baked en
- Stainless steel - Type #304, #4 satin finish
- Aluminum insect screen (installed on exterior side)
- Torx Security screws
- Thicker doors (up to 2 1/2")
- Odd inch sizes (maximum 24" x 24", minimum 12" x 6")
- Zinc electro-plating
- Galvanized A60 steel



#### Stock Sizes Available in Gray Primer & Dark Bronze

12 x 12  
18 x 12  
18 x 18  
24 x 12  
24 x 18  
24 x 24

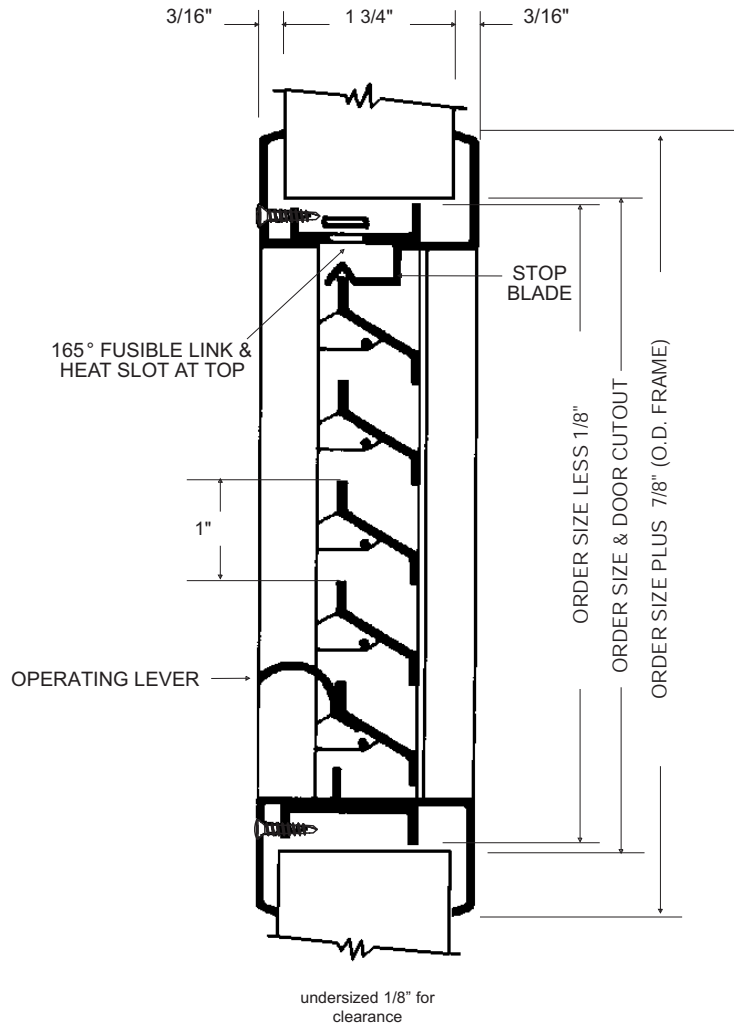

not to scale

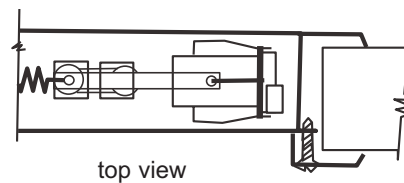

## L-A700 SERIES

### Aluminum No Vision Door and Partition Louver for 1 3/8", 1 3/4" up to 2 1/4" Thick Doors

- Frame .050" extruded aluminum
- Mitered corners secured with reinforcing clips
- Inverted "V" design
- Blades .050" extruded aluminum
- Counter-sunk mounting screw-holes interior side
- #8 x 3/4" Phillips TEK screws
- Available in uneven and fractional sizes
- Powder coat finish - (ASL) Aluminum silver
- Free area 70%

#### Available Options

- Powder coat color options - see page L2
- For exterior use specify drainage weep holes
- Thru bolts (TB) for 1-3/4" door when specified
- Aluminum insect screen (installed on exterior side unless requested otherwise)
- Torx Security Screws

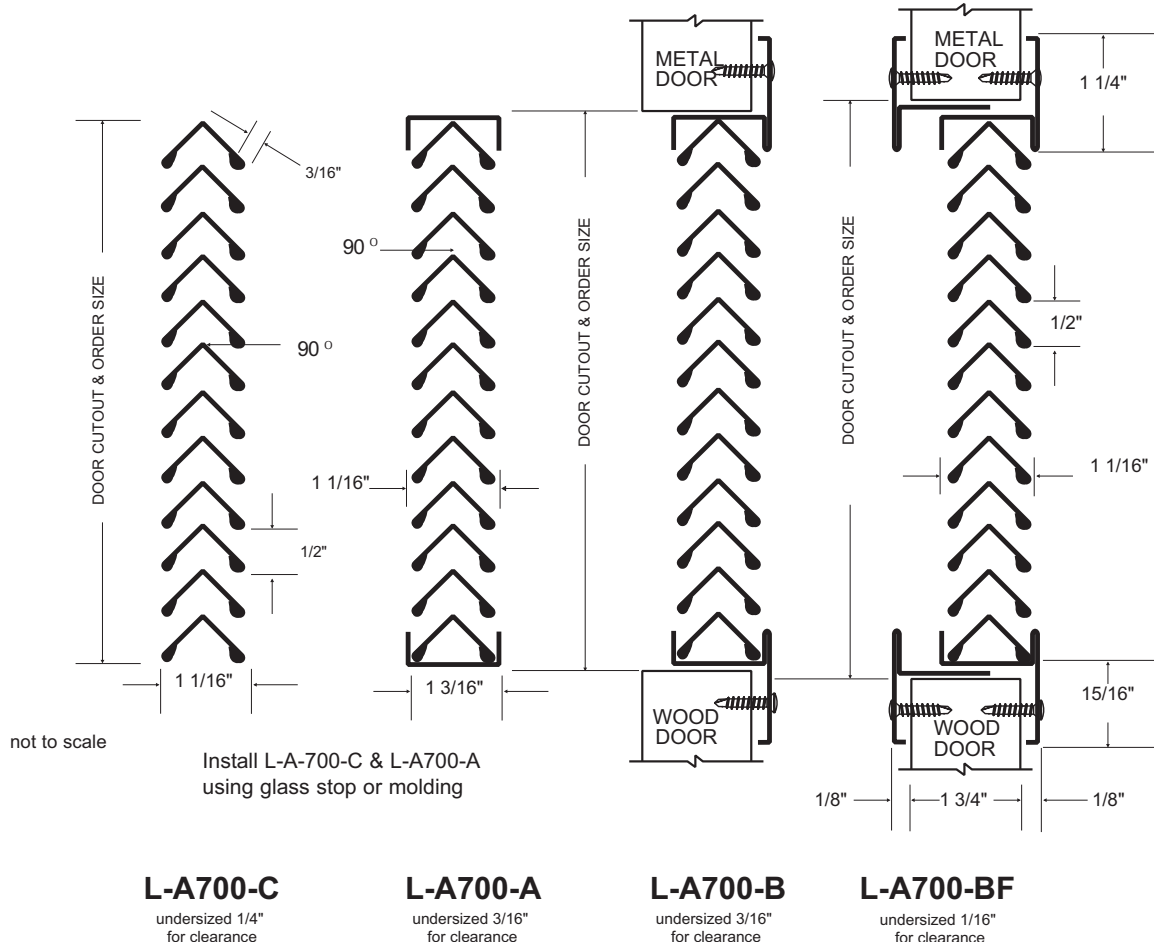
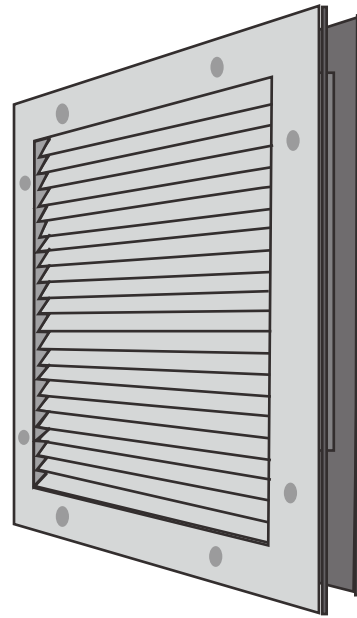

## L-VRSG-2, L-VRSG-3

### Vandal Resistant Security Louver

#### for 1 3/4" Thick Doors

- 18 ga. cold rolled steel frame
- Mitered and welded corners
- Welded reinforcing clips at corners
- Inverted "V" design
- Blades 24 ga. steel, hemmed edges
- 16 ga. steel, 3/4" x 3/4" security grille
- Powder coat finish - (GPZ) Gray Primer
- #6 x 1 3/4" Phillips Truss Head SMS
- Free area 45%

#### Available Options

- Powder coat color options - see page L2
- Thru bolts for 1 3/4" doors (suffix - "TB")
- Aluminum insect screen (installed on exterior unless requested otherwise)
- Torx Security Screws
- Zinc Electro-plating
- Galvanneal - A40 Steel

L-VRSG-2: HURRICANE/WINDSTORM  
Florida Product Approval FL10144

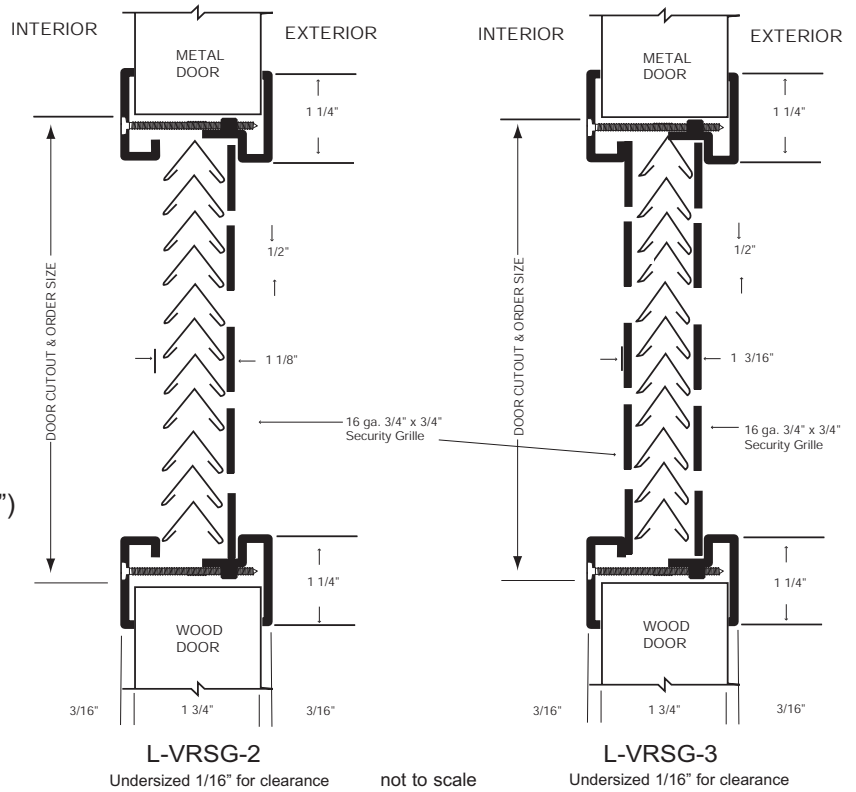

Designed for use on 1 3/4" thick doors manufactured within door industry tolerance of +/- 1/16".

## L-75 SERIES Darkroom Louver

### for 1 3/4" up to 2 1/4" Thick Doors

- 20 ga. cold rolled steel frame
- Mitered and welded corners
- Welded reinforcing clips at corners
- Blades .040" aluminum
- Counter-sunk mounting screw holes
- #8 x 3/4" Phillips head TEK screws
- Available in uneven and fractional sizes.
- Free area 55%
- Powder coat finish - (TBL) Textured Black

#### Available Options

- Powder coat color options - see page L2
- Thru Bolts (TB) for 1- 3/4" door
- Aluminum insect screen (installed on exterior side unless requested otherwise)
- Torx Security Screws
- Zinc electro-plating

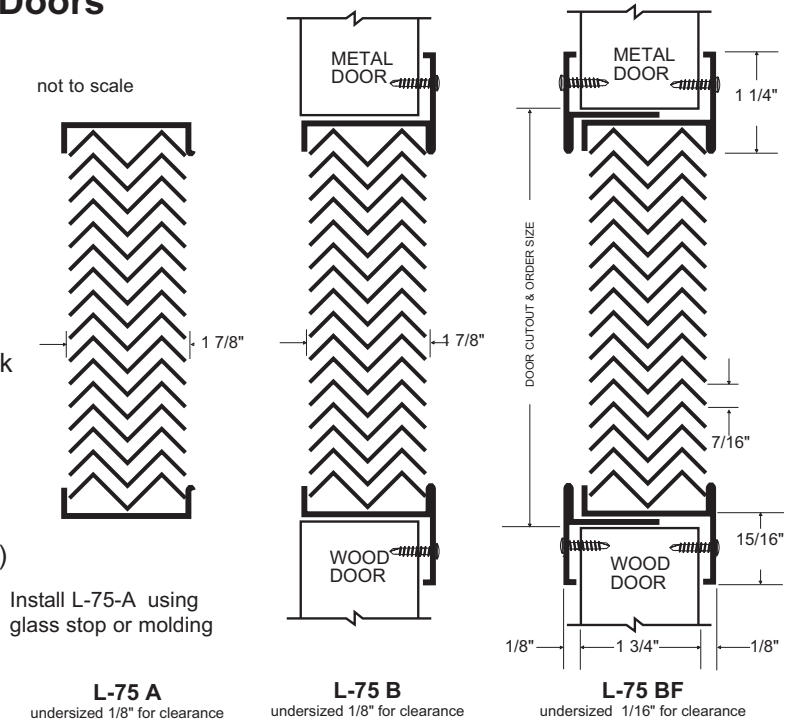



## SuperLite™ 1-W

U.S. Patent No. 7,090,906

### Fire Protective Safety Wired Glass

- 5/16" (8mm) thick
- Fits standard L-FRA100 and L-GLF100 Lite kits
- 3/4" X 3/4" Diamond pattern electrically welded steel wire mesh
- Heavy duty 7 mil durable safety film applied
- Maintains integrity when fractured or subjected to a hose stream
- Etched with UL classification on each piece
- Weight: 3 lbs./sq. ft.



**Fire-rating information:** Specify fire-rating required on order

- UL 9, UL10B, UL10C, NFPA252, with closed cell PVC foam glazing tape like NGP GT-116, GT-118, or GT132:

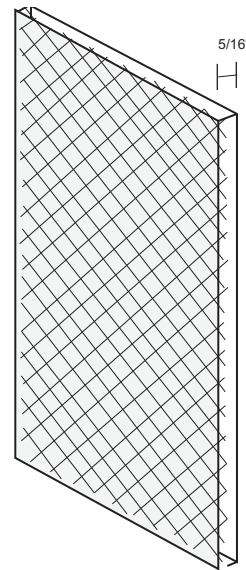

Rating	Application	Max. Visible Glass Area (Sq. Inches)	Max. Width Visible Glass	Max. Height Visible Glass
20, 45 Minute	Wood doors*	1,296	54"	54"
20, 45 Minute	Steel doors*	2,856	34"	84"
45 Minute	Side-lites, Borrowed lites	4,608	100"	100"
45 Minute	Transom lites	3,456	96"	36"
60 Minute	Wood doors*	960	12"	80"
90 Minute	Steel doors*	552	12"	46"
90 Minute	Wood doors*	100	10"	33"

\*with fire-rated glass Lite kit

### Impact Safety Rating Information:

Meets ANSI Z97.1, Class C

Meets CPSC 16CFR 1201 (Category I and II)

Complies with all IBC requirements for use in doors, side-lites, transom lites and borrowed lites.



## Pyran® Platinum F Fire-Protective Safety Glass Ceramic

- 3/16" (5mm) thick glass ceramic
- Heavy duty 7 mil durable safety film
- Neutral coloration - clear and wireless
- Advanced manufacturing process eliminates the need for surface polishing
- Etched with UL classification on each piece
- Weight: 2.5 lbs./sq. ft.



**Fire-rating information:** Specify fire-rating required on order

- UL9, UL10B, UL10C, with PVC foam glazing tape like NGP GT-116, GT-118 or GT-132.

Rating	Application	Max. Visible Glass Area (Sq. Inches)	Max. Width Visible Glass	Max. Height Visible Glass
20, 45, 60, 90 Minute	Doors* (non-temp rise)	2,736	36"	76"
20, 45, 60, 90 Minute	Side-lites, Borrowed lites, Transom lites	3,422	76"	76"

\*with fire-rated glass Lite kit

• **Impact Safety Rating Information:**

Meets ANSI Z97.1, Class C, Meets CPSC 16CFR 1201 (Category I and II)  
Complies with all IBC requirements for use in doors, side-lites, transom lites and borrowed lites.

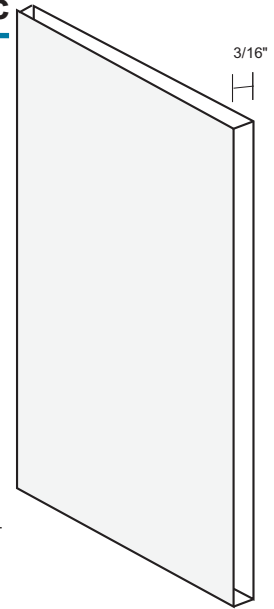

## Pyran® Platinum L Fire Protective Safety Glass Ceramic

- 3/8" (9mm) thick laminated glass ceramic
- Neutral coloration - clear and wireless
- Advanced manufacturing process eliminates the need for surface polishing
- Etched with UL classification on each piece
- Weight: 4 lbs./sq. ft.



**Fire-rating information:** Specify fire-rating on order

- UL9, UL10B, UL10C, with PVC foam glazing tape like NGP GT-116, GT-118 or GT-132.

Rating	Application	Max. Visible Glass Area (Sq. Inches)	Max. Width Visible Glass	Max. Height Visible Glass
20, 45, 60, 90 Minute	Doors* (non-temp rise)	2,736	36"	75"
20, 45, 60, 90 Minute	Side-lites, Borrowed lites, Transom lites	3,143	75"	75"

\*with fire-rated glass Lite kit

• **Impact Safety Rating Information:**

Meets ANSI Z97.1, Class C, Meets CPSC 16CFR 1201 (Category I and II)  
Complies with all IBC requirements for use in doors, side-lites, transom lites and borrowed lites.

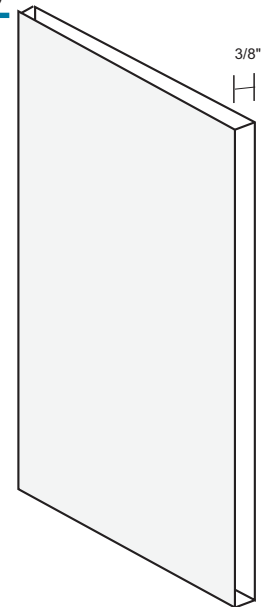

## SuperLite™ I 20 Minute Fire Protective Glass

- ¼” thick tempered fire glass
- Superior optical clarity – clear and wireless
- Most economical fire and safety rated glass available
- Etched with UL classification on each piece
- Weight: 3 lbs./sq. ft.



### Fire-Rating Information:

- UL9, UL10B, UL10C, NFPA252 with closed cell PVC foam glazing tape like NGP GT-116, GT-118, or GT-132

Rating	Application	Max. Visible Glass Area (Sq. Inches)	Max. Width Visible Glass	Max. Height Visible Glass
20 Minute No hose stream	Steel doors*	2,678	109”	109”
20 Minute No hose stream	Wood doors*	2,719	77-1/8”	77-1/8”

\*with fire-rated glass Lite kit

### Impact Safety Rating Information:

- Meets ANSI Z97.1, Class C
- Meets CPSC 16CFR 1201 (Category I and II)
- Complies with all IBC requirements for use in doors.
- This glass is cut to size then heat treated (tempered) to achieve its safety rating properties.
- Orders for this product are non-changeable and non-cancellable.

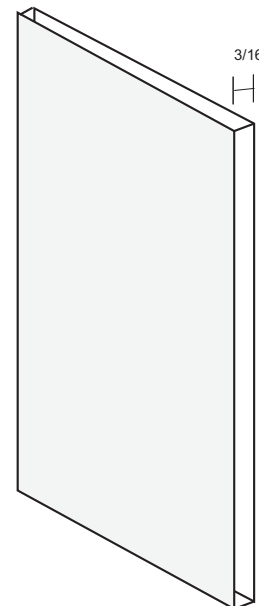

## Fire Protective Wired Glass

- 1/4" (7mm) Thick
- 3/4" X 3/4" Diamond pattern electrically welded steel wire mesh
- Clear glass - ground and polished both sides
- Maintains integrity when fractured or subjected to a hose stream
- Etched with UL classification on each piece

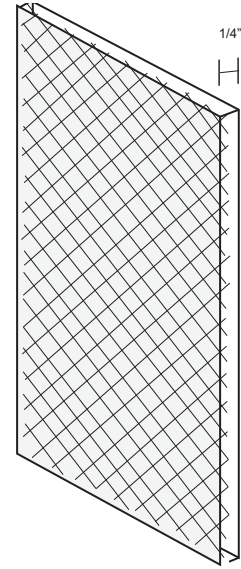

### Fire-rating information:



UL10B with Butyl glazing tape like NGP GT-16



UL10C, NFPA 252:  
20 min. with closed cell PVC foam glazing tape like NGP GT-116, GT-118 or GT-132.  
45, 60 or 90 min. with NGP GT-9800 or 3M GIS intumescent glazing tape.

Rating	Max. Visible Glass Area	Max. Width Visible Glass (Sq. Inches)	Max. Height Visible Glass
20, 45 Minute	1,296	54"	54"
60, 90 Minute	100	10"	33"

### Impact Safety Rating Information:

- Meets ANSI Z97.1 class C
- Complies with IBC 2000 requirements for use in doors
- Complies with IBC 2003 requirements for use in doors in other than Group E Education and Day care use and occupancy classifications and Athletic Facilities
- Does NOT comply with IBC 2006, IBC 2009 requirements for use in doors or sidelights. Allowed only in non-hazardous locations defined in IBC

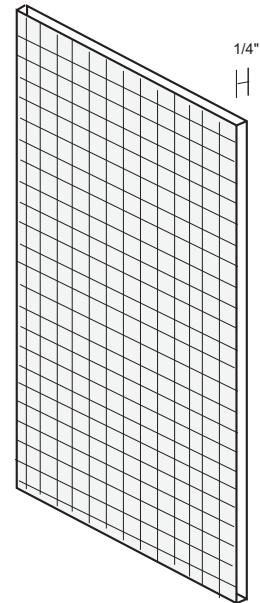

### Available Options

- 1/2" X 1/2" square pattern electrically welded steel wire mesh - Specify "square"

### 3 Ways to order glass from NGP:

1. Complete with Lite Kit & Glazing tape applied both sides
2. Glass with glazing tape supplied for both sides.
3. Glass only

## Tempered Glass

- Impact safety-rated: complies with IBC requirements for use in doors. Meets ANSI Z97.1, Class C and CPSC 16CFR 1201 (CAT I and II)
- 1/4" thick clear heat treated glass
- Approximately 4 times stronger than annealed (ordinary) glass.
- Breaks into small harmless fragments
- Can NOT be cut after manufacturing
- NOT fire-rated.

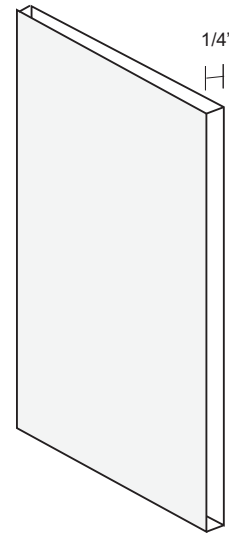

## Insulated Tempered Glass

- Impact safety-rated: complies with IBC requirements for use in doors. Meets ANSI Z97.1, Class C and CPSC 16CFR 1201 (CAT I and II)
- 1" thick - consists of two pieces of 1/4" thick clear tempered glass with 1/2" air space between and butyl seal.
- Increased energy efficiency.
- Approximately 4 times stronger than annealed (ordinary) glass.
- Breaks into small harmless fragments.
- Can NOT be cut after manufacturing.
- NOT fire-rated.

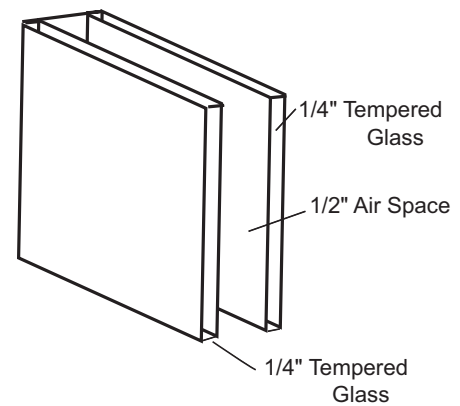

## Polycarbonate High Impact

- Impact safety-rated: complies with IBC requirements for use in doors. Meets ANSI Z97.1, Class C and CPSC 16CFR 1201 (CAT I and II)
- Burglary-resisting material. Meets UL Standard 972
- Available in 1/8", 1/4", 1/2" thicknesses (specify on order)
- Colorless transparent sheet
- Virtually unbreakable - 300 times stronger than ordinary glass
- Unlikely to shatter or chip when bombarded with thrown rocks, bricks or bottles.
- UV stabilized to resist solar exposure
- NOT Fire-rated

### Thicknesses Available

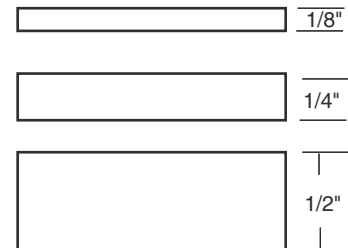

## L-Clips

### For Optional Reinforcement of 1 3/4" Hollow Metal Doors

- 20 ga. steel
- 4" length clip
- For spot reinforcement of cut-outs in hollow metal doors.



NGP Lite Kits on Fire-rated Hollow metal doors do NOT require L-clips or channels welded in the doors.

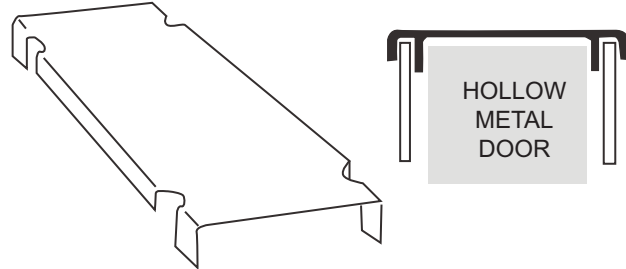

## Glazing Tape

**GT-16** 3/8" wide x 1/16" thick - 50' rolls.



- Butyl rubber glazing tape with adhesive both sides. Black
- For use in lite kits on UL10B Fire-rated wood-type or steel doors, using 1/4" fire-rated wired glass, up to 90 minutes.

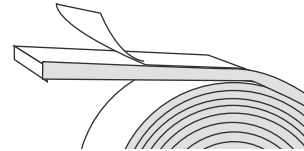

**GT-116** 3/8" wide x 1/16" thick - 150' rolls

**GT-118** 3/8" wide x 1/8" thick - 75' rolls.

**GT-132** 3/8" wide x 1/32" thick - 150' rolls.



- Closed cell PVC Foam glazing tape with adhesive both sides.
- Color is black.
- For use in lite kits on UL10C positive pressure fire-rated wood-type or steel doors, using 1/4" fire-rated wired glass up to 20 minutes
- For use in lite kits on UL10B or UL10C fire-rated wood-type or steel doors, using Pyran® Platinum F, Pyran® Platinum L, SuperLite™1, and SuperLite™1-W glass up to 90 minutes.

**GT-9800** 1/2" wide x 1/16" thick - 17', 21', 150' rolls.



- Intumescent glazing tape with adhesive one side. Black.
- For use in lite kits on UL10C positive pressure fire-rated wood-type or steel doors using 1/4" fire-rated wired glass, up to 90 minutes.

## Fire & Impact-Safety Rated Glass

Building Codes including the 2000 International Building Code (IBC) traditionally permitted wired glass installed in fire doors, fire windows and view panels to comply with ANSI Standard Z97.1 - Safety Glazing Materials Used in Buildings, rather than require compliance with the more stringent CPSC 16 CFR, Part 1201 - Safety Standard for Architectural Glazing Materials.

The 2003 edition IBC maintained the wired glass exemption from the CPSC 16CFR 1201 requirements except for Education and Day Care use and occupancy classifications, effectively eliminating standard non-safety rated wired glass from these types of facilities.

The 2006 edition IBC completely removed the wired glass exemption for all buildings; requiring all individual glazed areas in hazardous locations, specifically including doors and sidelights, to pass the test requirements of CPSC 16 CFR 1201 and comply with category classification I or II.

## Fasteners for Lites and Louvers



#6 x 1 3/4" TH Phillips SMS  
#6 x 1"  
#6 x 1 1/2"  
#6 x 2"  
#6 x 2 1/4"



Phillips Head  
Top View



TORX Security  
Top View



HEX Head  
Top View



#6 x 1 3/4" TH  
Phillips Stainless Steel SMS

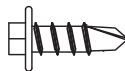

#8 x 1/2" HW  
TEK Zinc Screw

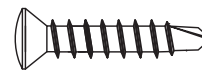

#8 x 3/4" OH Phillips  
TEK Screw  
#8 x 1"

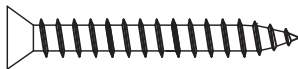

#8 x 1 1/2" OH Phillips  
Stainless Steel SMS

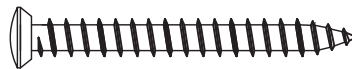

#8 x 1 3/4" OH Phillips  
U/C SMS  
#8 x 1"  
#8 x 1 1/2"  
#8 x 2"  
#8 x 2 1/4"

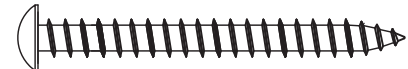

#8 x 1 3/4" OH Phillips  
Stainless Steel SMS

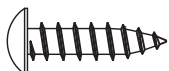

#8 x 1" PH Phillips  
Stainless Steel SMS  
#8 x 3/4"

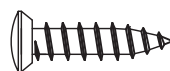

#8 x 3/4" OH Phillips  
U/C SMS

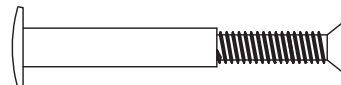

#8 - 32 Sex Bolt

PH = Pan Head  
OH = Oval Head  
TH = Truss Head  
HW = Hex Washer Head  
SMS = Sheet Metal Screw  
SNB = Sex Nut & Bolt  
U/C = Undercut



## Door Aligning Astragals

- Keeps pairs of doors without full length astragals aligned properly
  - Prevents over-swing of active leaf which may cause binding
  - Allows latching and locking hardware to function properly
  - Mounts neatly to edge of inactive leaf around the lock strike and/or flush bolts
- For 1 3/4" beveled edge doors
  - 9" height
  - 1/4" radius corners
  - 20 gauge cold rolled steel
  - DKB powder coat finish standard



### Available Options

- Powder coat color options - see page L2
- #304 Stainless Steel 20 ga., #4 brushed finish - suffix "SS"

575-Blank  
575-ASA  
575-T  
575-FB

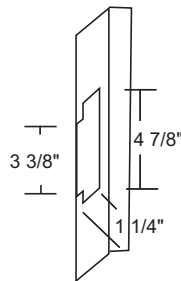
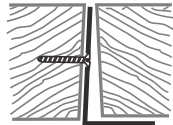
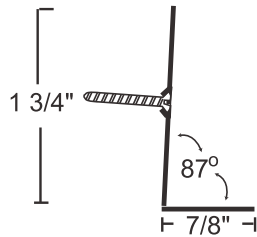

575-ASA

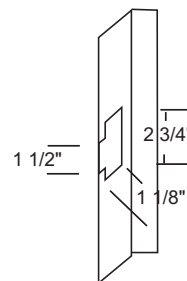

575-T

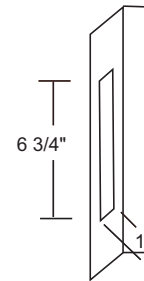

575-FB  
Standard  
Flush Bolt

565-Blank  
565-ASA  
565-T  
565-FB

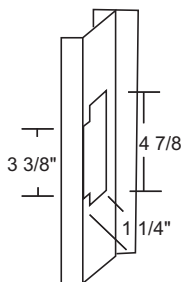
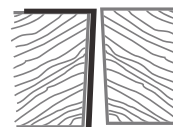
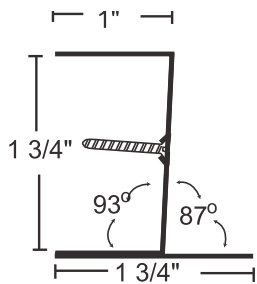

565-ASA

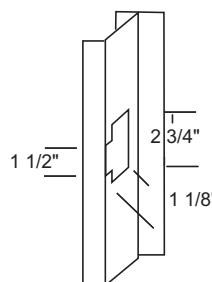

565-T

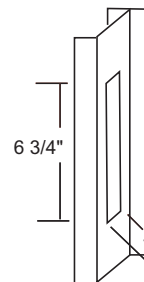

565-FB  
Standard  
Flush Bolt



## Metal Edges and Astragals

NGP Order Form (Page G54) indicating model number, hand, net length, hardware preps, and precise hardware locations must accompany all orders.

- 20 ga. cold rolled steel on edges and “Z” astragals
- 18 ga. cold rolled steel on astragal welded to edges.
- For 1 3/4” thick doors (inside dim. 1 3/4” actual)
- #8 x 3/4” flat undercut Phillips head SMS.
- Standard finish = Tan (T) powder coat

### Available Options

- Powder coat color options - see page L2
- Stainless Steel 20 ga., Type 304, #4 brushed finish - suffix SS”
- Galvanneal
- Torx Security Screws
- Special door thickness: 1 3/8”, 2”, 2 1/4”
- Lead lining .030” thick



### “Z” ASTRAGALS

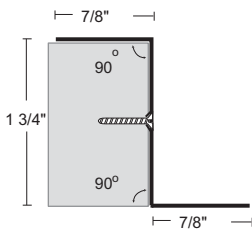

**570 SQUARE EDGE**

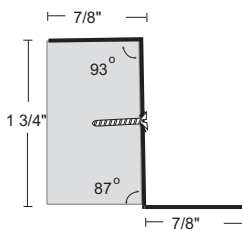

**572 BEVELED EDGE ON ACTIVE LEAF**

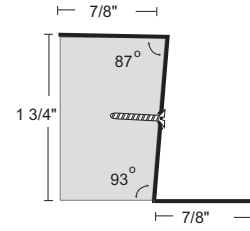

**574 BEVELED EDGE ON INACTIVE LEAF**

### DOOR EDGES

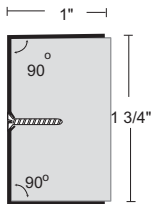

**540 SINGLE SQUARE EDGE**

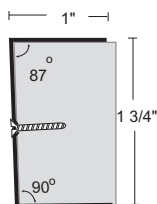

**542 SINGLE BEVELED EDGE**

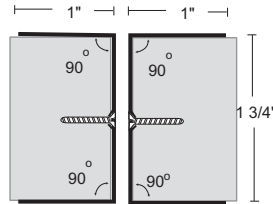

**541 SQUARE EDGE SET**

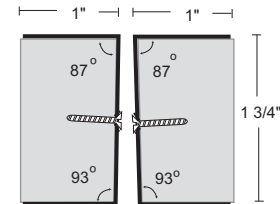

**543 BEVELED EDGE SET**

### DOUBLE EGRESS

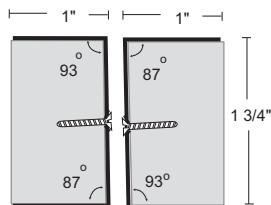

**545 PARALLEL BEVEL EDGE SET FOR DOUBLE EGRESS DOORS**

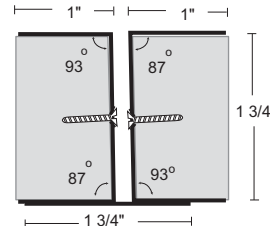

**555 PARALLEL BEVEL ASTRAGAL FOR DOUBLE EGRESS DOORS**

## Metal Edges and Astragals

NGP Order Form (Page G54) indicating model number, hand, net length, hardware preps, and precise hardware locations must accompany all orders.

- 20 ga. cold rolled steel on edges and “Z” astragals
- 18 ga. cold rolled steel on astragal welded to edges.
- For 1 3/4” thick doors (inside dim. 1 3/4” actual)
- #8 x 3/4” flat undercut Phillips head SMS.
- Standard finish = Tan (T) powder coat



### Available Options

- Powder coat color options - see page L2
- Stainless Steel 20 ga., Type #304, #4 brushed finish - suffix SS”
- Galvanneal
- Torx Security Screws
- Special door thickness: 1 3/8”, 2”, 2 1/4”
- Lead lining .030” thick

### ASTRAGAL ON ACTIVE LEAF

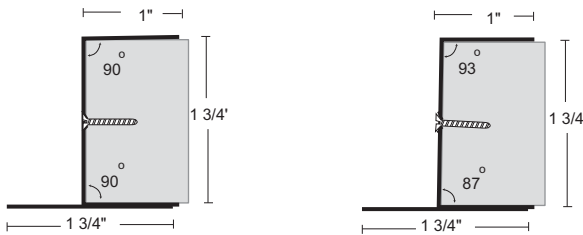

**550** SINGLE ASTRAGAL SQUARE EDGE

**552** SINGLE ASTRAGAL BEVELED EDGE

### ASTRAGAL ON INACTIVE LEAF

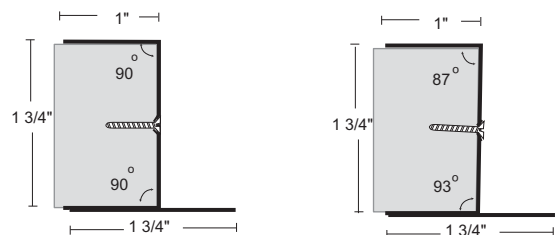

**560** SINGLE ASTRAGAL SQUARE EDGE

**562** SINGLE ASTRAGAL BEVELED EDGE

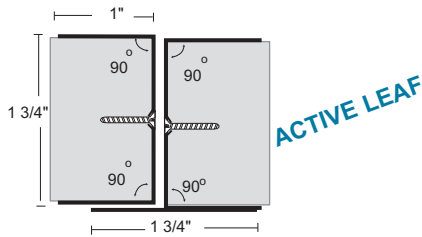

**551** ASTRAGAL SET SQUARE EDGE

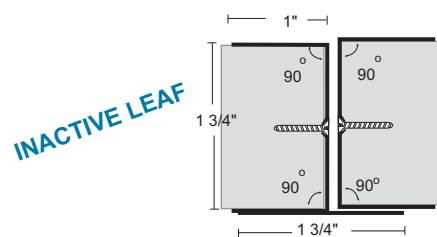

**561** ASTRAGAL SET SQUARE EDGE

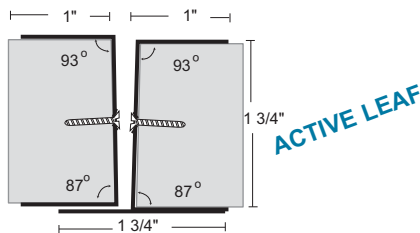

**553** ASTRAGAL SET BEVELED EDGE

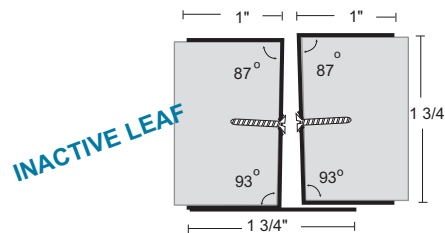

**563** ASTRAGAL SET BEVELED EDGE

Astragals mounted on active leaf that are prepped for a lockset will be notched for the strike lip, unless specified otherwise

**STEP 1**

## ORDER FORM FOR METAL EDGES/ASTRAGALS

ASTRAGAL ON ACTIVE DOOR				ASTRAGAL ON INACTIVE DOOR			
MODEL #				MODEL #			
551				561			
553				563			
550	--- RHR ACTIVE	--- LHR ACTIVE	---	560	--- RH ACTIVE	--- LH ACTIVE	---
552	QTY. (OUTSWING)	QTY. (OUTSWING)		562	QTY. (INSWING)	QTY. (INSWING)	
572				574			
OTHER MODEL #				OTHER MODEL #			
-----	--- LH ACTIVE	--- RH ACTIVE	---	-----	--- LHR ACTIVE	--- RHR ACTIVE	---
	QTY. (INSWING)	QTY. (INSWING)			QTY. (OUTSWING)	QTY. (OUTSWING)	

**STEP 2**

**ACTIVE**

**INACTIVE**

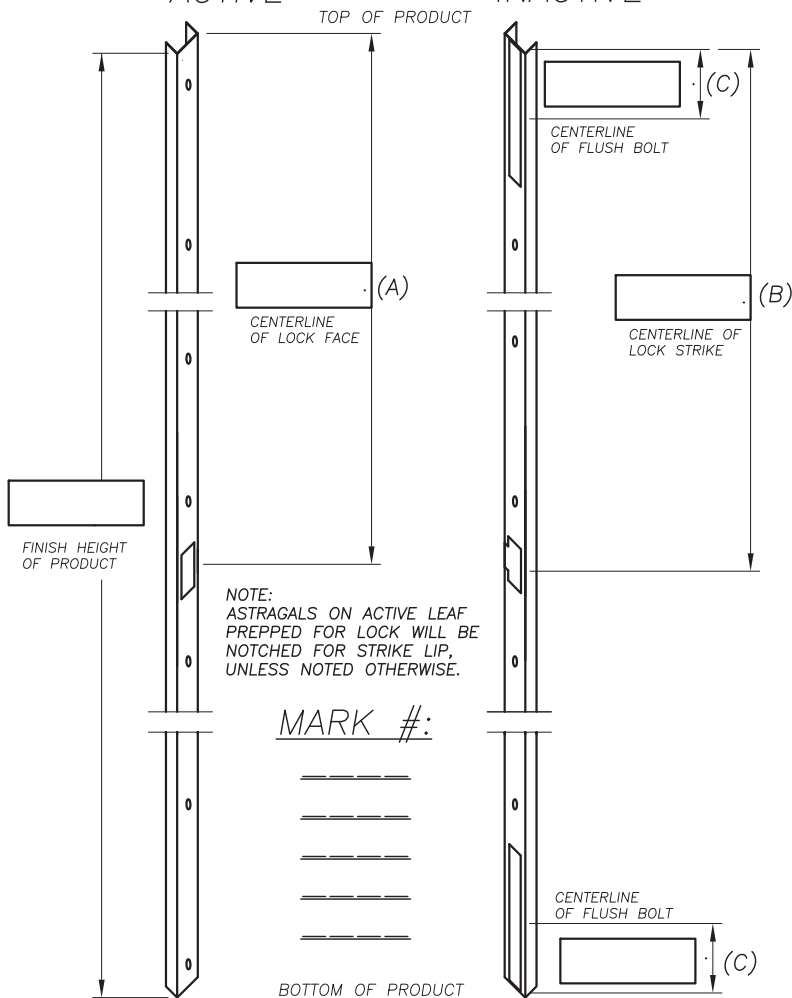

**STEP 3**

**PREPS**

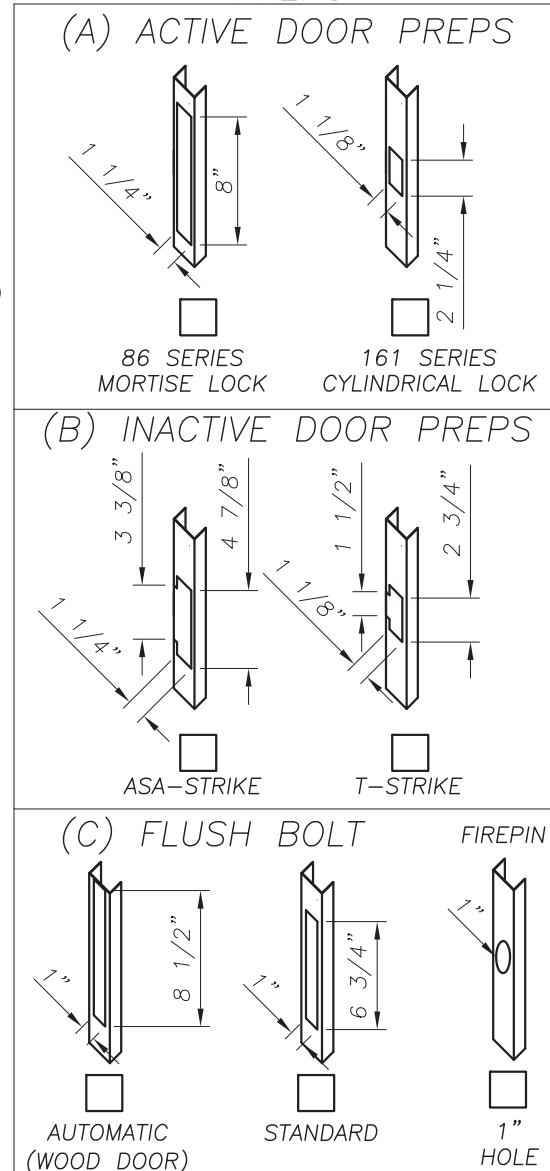

COMPANY:	
PO#:	DATE:
JOB NAME:	
MODEL #:	FINISH:
SIGNATURE:	

NOTE: SOME DEAD BOLT PREPS ARE AVAILABLE. PLEASE CONSULT FACTORY

PLEASE COMPLETE steps 1 thru 3:  
 1. Quantity for each hand  
 2. Hardware locations  
 3. Select hardware preps



**National Guard Products, Inc.**  
*The products you count on. The people you trust.*

*With such a knowledgeable team of experts, it's no wonder so many customers count on NGP. You can too.*

• THRESHOLDS • GASKETS • LITE KITS • LOUVERS • THRESHOLDS • GASKETS • LITE KITS • LOUVERS • THRESHOLDS • GASKETS • LITE KITS •

• GASKETS • LITE KITS • LOUVERS • THRESHOLDS • GASKETS • LITE KITS • LOUVERS • THRESHOLDS • GASKETS • LITE KITS • LOUVERS • THRESHOLDS • GASKETS • LITE KITS •

# Call NGP and get answers from a real know-it-all.

NGP stays on top of code compliance, specifications and product improvements for all your door hardware needs. Constant product testing and ongoing education have helped us create a team of experts who stand ready with immediate answers to your installation, compliance, and technical questions.

Call us today and get an earful.

**1.800.647.7874**



**National Guard Products, Inc.**

*The products you count on. The people you trust.*

• THRESHOLDS • GASKETS • LITE KITS • LOUVERS • THRESHOLDS • GASKETS • LITE KITS • LOUVERS • THRESHOLDS • GASKETS • LITE KITS •

**Contact:**

**Phone:** 800-647-7874  
**Fax:** 800-255-7874  
**www.ngp.com**

**Corporate Headquarters:**

**NATIONAL GUARD PRODUCTS, INC.**  
 4985 E. Raines Road  
 Memphis, Tennessee 38118

**Mailing Address:**

P.O. Box 753430  
 Memphis, Tennessee 38175